

# RADIO PHOTO 5,000 MILES

## PUBLIC SERVICE KEY TO CLARIFIED ETHER

MILLIONS OF VOTES NEEDED TO SPUR CONGRESS

Broadcasting Stations and Readers Aid Radio Digest in Campaign for Less Congestion

CHICAGO.—"I am with you on your proposal to force some legislation to clarify the air." "Best thing Radio Digest has started out to accomplish." "Your campaign will be enthusiastically supported by our Radio club, which boasts two hundred members," etc., until the editor's desk has been completely swamped with letters.

Communications from every section of the United States bear mute witness to the popularity of the "Consensus of Opinion" voting plan and the campaign to lessen the present undesirable congestion of the air.

Last week the Kintner plan was reprinted. It was given to readers so that they could see what some sort of plan would do for Radio. It has at last become evident to listeners that the present unorganized scheme of things cannot long endure.

### Radio Is Public Utility

Radio has become too much of a necessary service to the public to be lightly cast aside. It has become a public utility, and all of this without an effective law to guide it. The good judgment of Secretary Herbert Hoover, acting as best he can, has been Radio's only saviour.

The ultimate solution of the congestion problem, Radio Digest believes, will be in

(Continued on page 2)



## HONOLULU TO NEW YORK IN 20 MINUTES

Photos Show Navy Game

Record-Breaking Photo Transmission Beats Fastest Transportation by Ten Days

(See Photographs on Page 6)

NEW YORK.—Pictures flashed by Radio traversed the hitherto undreamed of distance of 5,000 miles in the short span of twenty minutes time, when photographs of the war department's manoeuvres at Hawaii were recently sent from Honolulu to New York.

The revolutionary feat of Radio photo transmission beat by ten days the fastest known means of transportation, airplane mail and fast mail ship. If the fastest mail boat leaving Honolulu were to carry the pictures to San Francisco, eight days would be required for the trip, and if an air mail plane at San Francisco carried the photographs to New York, another two days would be consumed.

### How Feat Was Accomplished

The pictures transmitted were taken near Honolulu during the recent American army manoeuvres and naval games there. They were developed, converted into electrical impulses of varying intensity, and then transmitted by land wire to the

(Continued on page 6)

Miss Dorothy Trombley, cellist of the Trombley Trio, who broadcast from KDKA.



Horraine Allen, "Queen of the Ivories," at Station KFMQ.

Claire Windsor, blonde movie star, listening during a lull in the filming of one of her pictures. She is an ardent listener.



# BROKESHIRE GIVES GOLD CUP SURPRISE

## SPRINGS FROM OBSCURITY TO 14TH POSITION

Battle Continues for 1925 Title as World's Greatest Announcer—Hay Keeps Lead

Well! Surprises are beginning to show in the announcing ranks. According to Shakespeare, Hoyle or some other person, you can't keep a good man down. To prove this, Norman Brokenshire, one of WJZ's staff announcers came from obscurity and jumped into fourteenth place.

Last week we told you to look for surprises and we meant it. It seemed about time that some dark horse would step into the limelight and try to steal the plaudits of the fans. Norman Brokenshire jumped considerable, but not quite enough, to get into the "fortunate seven."

The "Solemn Old Judge"—George D. Hay, announcer at Station WLS, and winner of last year's Gold Cup—is still in the lead. Six announcers behind him are still in the same respective positions that they were last week. Of course, they have improved their standing by getting additional votes, but the position is still the same.

The Radio Digest Second Annual Gold Cup Award is creating considerable interest throughout the country, as evinced by the large number of votes now being received by the editor of the contest. From every state in the Union, Canada and Mexico, announcers are being nominated by numerous fans, as their choice for the Gold Cup.

### Standing of the Leaders

Each week the standing of the sixteen leaders is changing. No one knows who will be favored next week. It is up to the fans. They are the ones who say whether or not an announcer should be up among the leaders. Every week brings a new thrill, a new name, a new favorite. The standing at the close of last week showed the following names as the "first sixteen":

| Position | Name and Station        | Votes |
|----------|-------------------------|-------|
| 1.       | George D. Hay, WLS      | 3,599 |
| 2.       | Charles McNamee, WPA    | 2,738 |
| 3.       | The Elmer Band, WBAP    | 2,400 |
| 4.       | Harry Field, KPNP       | 2,091 |
| 5.       | E. W. Arling, KDKA      | 2,013 |
| 6.       | N. Dean Cole, WHO       | 1,692 |
| 7.       | W. G. "Bill" Hay, KFKX  | 1,685 |
| 8.       | Lambert Kay, WGL        | 1,597 |
| 9.       | Gene Rouse, WGLW        | 1,486 |
| 10.      | Stanley W. Barnett, WOC | 1,452 |
| 11.      | Robert Emery, WED       | 1,338 |
| 12.      | Adams Gibson, WFAA      | 1,310 |
| 13.      | Charles Fountain, WFAA  | 1,286 |
| 14.      | Norman Brokenshire, WJZ | 1,253 |
| 15.      | Leo Fitzpatrick, WDAF   | 1,246 |
| 16.      | Jerry Sullivan, WQX     | 1,240 |

Nine new announcers have been nominated for the contest during the past week. Every one of them has as much chance of winning the Gold Cup as the first sixteen men. It will be a little while yet before the winner is picked.

The new announcers are as follows:  
 CNRA, A. E. Flinn, WCBR, Chas. H. Messer;  
 KPNP, Christian Sherin, WCR, Helen G. Halseid;  
 KOP, H. G. Rands, WGL, Tom Boyd, Gray;  
 WBAO, Prof. Fred Tounslay, WJBO, Harry Geise;  
 WDAW, Eugene M. Konecky

### American Stations Reach Australia on Recent Test

NEW YORK—First prize for the best broadcasting station to reach Australia was presented to Station WAHG recently. The test was to determine what effect the equinox might have upon Radio waves crossing the equator.

Among the other stations heard in Australia were, WOR, Newark, N. J.; WLW, Cincinnati, Ohio; WCCO, Minneapolis, Minn.; WMAQ, Chicago, Ill.; WOC, Davenport, Iowa, and KFI, Los Angeles.

## CONGESTION PROBLEM

(Continued from page 1)

the survival of the fittest. The stations broadcasting the best programs—programs that the public want—in the best way possible, will continue to exist, while those who persist in crowding the air with mediocre material with generator hums and "asides" thrown in for good measure, will be asked to cease operation—by the public.

Service, then, is to be the deciding factor. Printing Firms and Stations Help Millions of "Consensus of Opinion" votes (top of page two) are needed. Thousands of these have been sent to Radio Digest already, but hundreds of thousands must be filled in and tabulated into a gigantic appeal to congress.

Broadcasting stations are lending their aid and calling the attention of their listeners to the popular campaign.

Five readers owning printing establishments have printed duplicates of the "Consensus of Opinion" voting blank at their own expense and are distributing them by the thousands to their friends.

The less congestion campaign continues. Get every one of your friends to help make broadcasting a pleasure instead of a nuisance. A logical plan for giving first privileges to stations serving the public best, must be presented to congress and made a part of the nation's laws.

The new broadcasting station of the National German Broadcasting industry has just been completed. It will be put into operation as soon as tests have been completed.

## FANS WILL SELECT WMBF'S NEW VOICE

### PUBLIC TO VOTE ON SUCCESSOR TO J. H. JAY

Applicants Go Before Mike on June 1—Jay to Be Director of the Superstation

MIAMI, Fla.—The whole nation will participate in selecting the new announcer for WMBF, Fleetwood hotel at Miami Beach, when Jesse H. Jay, present announcer, leaves WMBF to direct and announce the new superpower broadcaster soon to be erected here.



Jesse H. Jay

The announcement has just been made by Com. A. Perry Stolz, owner of the Fleetwood, that starting June 1, several applicants for the position of announcer at WMBF will be permitted to take charge of the microphone.

Votes from listeners will be requested and the announcer receiving the most votes will be given the position. In case of the vote running close, Radio fans will be given the opportunity of selecting the best man in an elimination contest.

Jesse H. Jay, announcer for WMBF since it took the air, who is famous for his "It's June down here, folks," will take over the reins at the new 2,500-watt superstation recently announced as in the process of construction at Miami Beach. The Carl G. Fisher interests, who built and made the Indianapolis Motor Speedway famous, are promoting and supporting the new superpower broadcaster.

### Amateur Boxing Tournament Re-broadcast to Argentina

BOSTON, Mass.—Fans in South America recently heard a ringside account of the international amateur boxing tournament held here. The blow-by-blow description was picked up by KDKA from Station WBEZ, and then rebroadcast to the broadcasting station "La Nacion," located in Buenos Aires, on short wave lengths. A number of embryo fistie celebrities from South America attended the fights, and it was for the benefit of their countrymen that the bouts were broadcast.

### American Legion Gets Roxy Radio Fund as Endowment

WASHINGTON, D. C.—The American Legion has just had turned over to it as a permanent endowment \$85,000 which is what remains of the \$200,000 collected by the Roxy Radio fund. This endowment will be administered on behalf of the veterans by the Legion to provide all public and private hospitals and other institutions which are for world war veterans with Radio equipment and maintain that equipment indefinitely.

The historic London broadcasting station on the top floor of the Marconi house has finally closed down. The new station is on the roof of the Selfridge store, operating under the old call letters of 2LO.

# CONTENTS

Radio Digest, Illustrated, Volume XIII, Number 7, published Chicago, Illinois, May 27, 1925. Published weekly by Radio Digest Publishing Company, 510 N. Dearborn Street, Chicago, Illinois. Subscription rates, yearly, Five Dollars; Foreign Postage One Dollar additional; single copies Ten Cents. Entered as second class matter at the post office at Chicago, Illinois, under the Act of March 3, 1879.

|   |         |
|---|---------|
| All the Live News of Radio.....   | 1 to 6  |
| KFI—The "Radio Central Superstation".....   | 4-5     |
| Operating and Trouble Shooting, for the Owner of a Radiola K.....   | 7       |
| Advance Programs for the Week at All the Larger Stations.....   | 8 to 13 |
| An Evening at Home with the Listener in, a chart in Eastern, Central and Pacific time, showing when to listen in for your favorite station..... | 14-15   |
| Editorials; Ind-Gest; Condensed by Dielectric.....  | 16      |
| Goodrich Four Tube Dry Cell Semi-Portable, by W. M. Goodrich.....   | 17      |
| A. B. C. Course in Radio-Fundamentals, Chapter IX—Action of Inductance and Capacity in A. C. Circuits, by David Penn Moreton.....               | 19      |
| Two Tube Tandem Rheostat Control, by M. V. Anderson.....  | 21      |
| Questions and Answers.....  | 22      |
| Directory of Radiophone Broadcasting Stations, Part II.....   | 23      |

## Looking Ahead

The Year's Most Important Advance in Radio, control of tuned radio frequency so that amplification per tube can be brought up to eight, will be the subject of the new series beginning next week by Milo Gurney. Six articles are scheduled and, to understand the new principle involved, it is necessary that the reader follow them through slowly and carefully. The sets you will either build or buy next fall will utilize this new circuit.

KFAB, the Nebraska Buick Automobile Company Station, will grace page five next week. A number of photographs and the story of this popular broadcaster directed by Gayle Grubb, will be given. WAHG, Richmond Hill, N. Y., and CKY, Winnipeg, are soon to be featured.

Are You Saving Ballots for Your Favorite Announcer? If so, you will be interested in watching the changing standings of the leading—and other—candidates. The Gold Cup Award has a long time to run. Many surprises may be sprung before the competition has ended. Stand by.

Voltmeters, Ammeters and Wavemeters, the instruments by which the Radio man learns what is going on in his circuits, will be taken up next week by Professor Moreton in his A. B. C. course. By the flickering of the pointers, the action of the unseen and very minute forces are unmistakably followed.

### Newsstands Don't Always Have One Left

WHEN YOU WANT

# Radio Digest

YOU WANT IT!

BE SURE OF YOUR WEEKLY COPY BY SUBSCRIBING NOW

SEND IN THE BLANK TODAY

Publisher: Radio Digest, 510 N. Dearborn St., Chicago, Illinois.

Please send enclosed check M. O. for Five Dollars (Six, Foreign) for One Year's Subscription to Radio Digest, Illustrated.

Name.....  
 Address.....  
 City..... State.....

## STATION GLEANINGS AND NEWSY BRIEFS

### SUNDAY MORNING CHIMES FROM STATION WJZ

American Legion Night at KOA May 29—Operatic Numbers May 28 From Station CNRW

Sunday morning does not seem complete somehow without the sound of church bells wafting through the morning air, and with this in mind, Station WJZ is going to supply the Radio audience with such an atmosphere every Sunday morning at 10:40.

Friday, May 29, will be American Legion night over KOA, Rocky Mountain broadcasting station. The entire program, beginning at 9:10 p. m. Central time, will be given under the auspices of Post No. 10 at Boulder, Colo.

A program of operatic numbers in which several of Winnipeg's prominent operatic singers will take part, is announced by Station CNRW on the night of Thursday, May 28.

Every Tuesday evening, Station WEBJ, New York, will broadcast one and one-half hours of dance music. It will begin at 7 o'clock, when Dan Barnett's orchestra will take the air. At their conclusion, McLean's dance orchestra will follow.

Daylight saving time means an extra hour of work for Arthur Bagley, director of the Tower health exercises. The reason is that while WEBJ have switched to the new time, the Washington crowd get their exercises from WCAP, faithful to standard time.

Mary Lawton, former actress, now devoting herself to literary pursuits, will continue her series of talks from Station WJZ. Her talks are on the life of the Clemens family, particularly Mark Twain, as told to her by an old servant of the family, one Katie Leary.

The Neapolitan trio, consisting of two dark-skinned natives of Italy and a white cockatoo, recently gave an afternoon concert from WGY, officially announcing the presence of spring.

The WEAF grand opera company was recently heard giving Verdi's opera "Falsetto." This is an opera in three acts and the text is by Piave adapted from Hugo's drama, "Le Roi S'Amuse. The scene is laid in Mantua and vicinity in the sixteenth century.

One of the most unusual gatherings of stage and screen folk was held in the Gubel brothers store in Philadelphia May 12. Station WIP, the official station of the store, broadcast the event, which was one of the largest ever handled.

"Lucia di Lammermoor" was recently broadcast from Station WGY, Schenectady, N. Y. This is one of a series of grand operas presented by WGBS and it is the first time that the General Electric company station has been linked with WGBS.

The Eveready hour broadcast Tuesday evening, May 12, gave the play, "A Pair of Shoes," through Stations WEAF, New York; WFI, Philadelphia; WEEL, Boston; WEAR, Cleveland; WCCO, Minneapolis-St. Paul; WOC, Davenport and WSAL, Cincinnati.

Brooke Johns, banjoist and entertainer, recently entertained fans from Station WOR, Newark, N. J. His banjo has been autographed by President Coolidge and the Prince of Wales.

Station KSD recently broadcast the music and dialogue of a special pageant given by the Catholic Students' Mission crusade, a national organization, from the stage of the Municipal theater in Forest park, St. Louis.

### More Stations for Chicago Are Now Ready to Operate

CHICAGO, Ill.—This city continues to add to her already large number of stations. The two latest additions are WFKB and WIBO. Station WFKB is on 217.3 meters using 300 watts. WIBO is at the present time enlarging their station, and will operate on 226 meters using 500 watts.

Station WCBZ, located at Chicago Heights, Ill., is now on the air using 217.3 meters wave length and 50 watts.

Destroying a new antenna, a youth in England cut down a heavy ash tree thirty-one feet long and dragged it for more than a quarter of a mile to his home. The judge did not sympathize with him, but fined him \$5.

### YACHT ZENITH WILL REPORT YACHT RACE

CHICAGO.—"Blow-by-blow" details of the Chicago Yacht club Mackinac race will be broadcast "direct from the waves," according to Commander E. F. McDonald, Jr., whose 96-foot yacht "Zenith" will follow and broadcast the race, with the call WSAX. The yacht is equipped with a 1000-watt transmitter and will broadcast simultaneously on 268 and 61 meters.

### MYSTERIOUS ARTIST REMAINS UNKNOWN

CINCINNATI.—The unknown artist who recently presented child dialect readings of James Whitcomb Riley's poems from Crosley station WLW still remains a mystery. She will return to WLW Wednesday, May 27, when listeners will be invited again to guess by phone, mail or telegraph who the reader is and her age. She has created a sensation with her child readings.

## MADGE THINKS RADIO'S THE THING



Scintillating, sparkling Madge Kennedy, star of stage and silver-sheet, is one of the more broadminded members of the acting profession who thinks that Radio will never be a detriment to motion pictures or the legitimate stage, but that when properly used can be of real aid in stimulating the interest in and attendance at the shows. Miss Kennedy has been heard over nearly a score of broadcasting stations and so can add "broadcast artist" to her long list of accomplishments.

### ABE LYMAN HOLDS BIG PARTY FOR KNX FANS

Never Realized His Large Acquaintance Among Devotees

LOS ANGELES, Calif.—Abe Lyman, leader of the famous Los Angeles Ambassador hotel Cocoanut Grove dance orchestra, did not know how many friends he had until he broadcast an invitation for all his Radio friends to attend an all day picnic and dance to be held at La Joya Lodge, a hill and canyon estate about forty miles from Los Angeles.

La Joya can accommodate about 40,000

people nicely and although it was impossible to obtain an accurate estimate of the number who accepted Abe's kind invitation due to the rugged nature of the canyon country, still it was some big party as traffic officers stations on the roads leading to La Joya will readily admit.

### Mystery of WEAF Singer Is Causing Plenty of Comment

NEW YORK.—With the receipt of 2,000 letters by WEAF inquiring as to the name of "The Man in the Silver Mask," who is heard with the Silvertown Cord orchestra, the whole thing still remains a deep-dyed mystery.

## DERBY MAKES RADIO BOW ON TWO MIKES

### WGN TO HANDLE 500-MILE SPEEDWAY RACE NEXT

WHAS and WGN Make First Broadcast of Classic Horse Race at Churchill Downs

LOUISVILLE, Ky.—Broadcast by Station WHAS here, and WGN, Chicago, by remote control, the famous Kentucky Derby on May 16, for the first time in history was heard by all Radio fans within the range of these two stations.

WHAS, owned by the Courier-Journal, the famous newspaper of the south, made famous by the late Colonel Henry Waterston, began its program at noon with talks and readings by world-famous authors and writers who vividly portrayed the locale of the classic horse race. Credo Harris, novelist and director of WHAS, was responsible for the program which included reading of the famous news story of 1889, "How the Derby Was Won," by Gen. Harrison Carter.

At the track WHAS had microphones in the cupola, on the grandstand, the bandstand and on the track. Even the musical rhythm of the horses hoofs pounding the turf could be distinguished by listeners.

WGN's Part in Derby  
WGN with its corps of announcers headed by Quin Ryan, made the Derby extremely interesting for everyone. The Chicago station was connected by telephone wires with the Churchill Downs track at Louisville, where microphones were located in the cupola, the dingo hall, and just above the heads of the enthused spectators in the grandstand.

A fourth WGN microphone was used in the press box by Jack Dempsey, the world's best known race track "clocker," who called every race as it was run, following with a summary. And even the ever-changing odds were reported to the Radio audience as fast as they were posted on the rear board—faster than even the fleetest "bookie's telephone system" could carry them.

500-Mile Races Next Week  
The Indianapolis Speedway 500-mile race on Decoration Day, May 30, will be the next sport classic to be broadcast by the ever vigilant WGN, of Chicago, with Quin Ryan playing the leading part.

From 9 a. m. to 4 in the afternoon, Central standard time, this gripping spectacle will be on the air. Microphones in the pits, the grandstand, bandstand and the announcer's private tower studio, will capture everything and bring it to the homes of the listeners.

The music of the Speedway massed band of 1,075 pieces, the shouts of the crowd and the purring roar of the speeding cars—all will be there, right in your loud speaker.

### Station Changes

Station WEBR, owned by the Howell Electric company, Buffalo, N. Y., moves up a bit. It recently held the formal opening of its new studio in the Bramson building with a big program. This station now operates on 244 meters with 250 watts. WEBR made its bow to the Radio fans six months ago with only five watts capacity.

Preparation for the opening of Station CNRW, the latest of the Canadian National Railway's chain across Canada, are proceeding rapidly. The new station will come on the air early in June, it is expected, and will be one of the most powerful in the Dominion.

A change in the wave length of Station CNRR at Regina, Saskatchewan, is announced as a result of the conflict between the wave length of 312.3 meters recently allotted with those of Minneapolis and Denver. The Regina station of the Canadian National chain is now on a wave length of 356 meters.

### Woman Wants Radio Divorce

LONDON, Eng.—English law courts were startled recently when a woman asked that the divorce decree be sent to her by Radio. She intended sailing for America to remarry, when she found that the decree would not be made absolute until after she had sailed. The request was refused, but she was told her lawyers could Radio the "good news" to her.

### Coolidge Protograph for KFI

LOS ANGELES, Calif.—KFI is in receipt of an autographed photograph of President Coolidge, which is framed and displayed in the reception room with one of Herbert Hoover, also dedicated to the station. The broadcasting activities of both men have been peculiarly bound up with KFI.

# KFI—The "Radio Central Superstation"

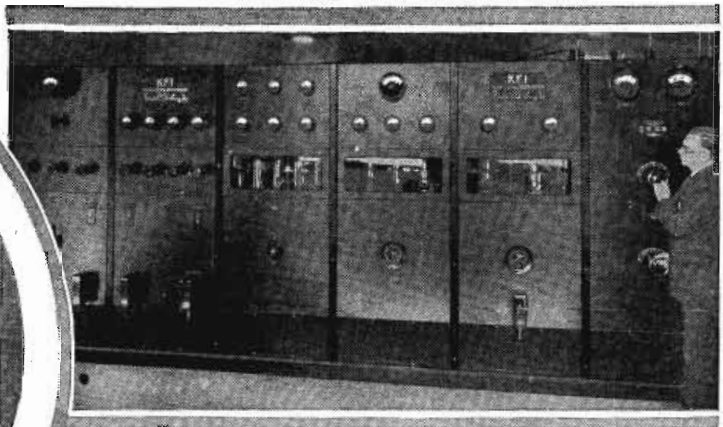

Control panels for KFI's 5,000-watt transmitter which is behind.



Earle C. Anthony, owner of KFI, telling the fans what he thinks of the Packard automobile. He distributes them!

Control room, showing operator sitting at desk. He has a clear view of the transmitting panel through a plate glass partition.

A HIGH degree of foresight and vision, and several times that much financial courage is necessary for an individual or company, in no way connected with Radio in the commercial sense of the word, to spend around \$200,000 in three years in an endeavor to foster a new means of entertainment and put it on a high plane, when there is no assurance of any kind that the venture will turn out to be more than a steady drain on the pocketbook.

Earle C. Anthony, motor car distributor of Los Angeles, is such a man, and his station, KFI, is just such a station as one would expect him to operate.

In the fall and winter of 1921, when the first big Radio craze was sweeping the United States, Mr. Anthony became deeply interested in the broadcasting side of Radio and realizing its future and possibilities, in the spring of 1922 he put the first KFI call on the air. Since that time, Easter Sunday, 1922, KFI has been on the air daily without exception and has grown with remarkable speed from the puny 50-watter that put phonograph selections on the air to the immense plant that it now takes to house and operate the 5,000-watt super-

station. There are several sound fundamental ideas back of KFI's growth—ideas backed by a lot of money that business associates have pointed out as merely thrown away. The ultimate will never be reached, but KFI has gone a long way toward the goal set. The first 50-watt set did not serve long before it was decided that 100 watts was the minimum a broadcast station should use, and accordingly a station of that size was erected. It is still a pleasant memory to those who remember it.

But soon after the 100-watt station was in operation the 500-watt Western Electric sets showed their worth and one was purchased for KFI, going on the air January, 1923. Although the 500-watt set gave yeoman service for two years without missing a program, Mr. Anthony realized it was far from perfection, and in the spring of 1924, hearing that the Western Electric company would soon market a new Type D 5-K.W. set, far superior to anything on the market, a trip to New York was made, the outcome of which was the signing of a contract for the first 5,000-watt station of the new type. According to contract the new transmitter was the first of its type to be erected and the first to go on the air, making its initial bow to Radioland on December 30, 1924. A feature at the time was the switching over to the new set from the old in less than two minutes. Mechanically and electrically, the new KFI set is as near perfection as science can produce at this time. It is a beauty of design and finish. To grasp an idea of its size realize that the control room only for the new set is the exact size required for the 500-watt type of Western Electric set and the new set, in addition to the control room, occupies two other rooms of at least double that space each.



The Parks Sisters, June and Frances (right) who came to KFI after appearing in vaudeville engagements in and around Los Angeles. Below, generator room, showing controls. Note the double set of motor generators. The second set is for emergency use.

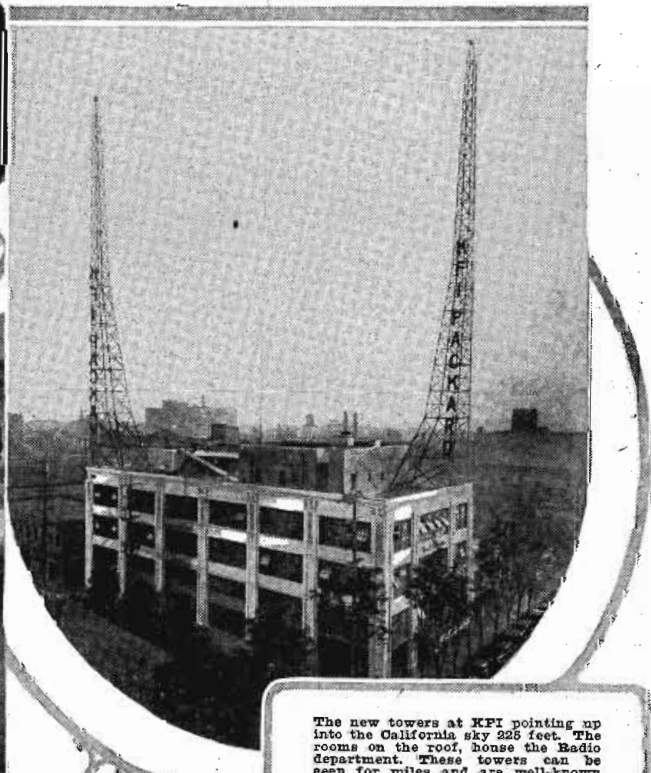
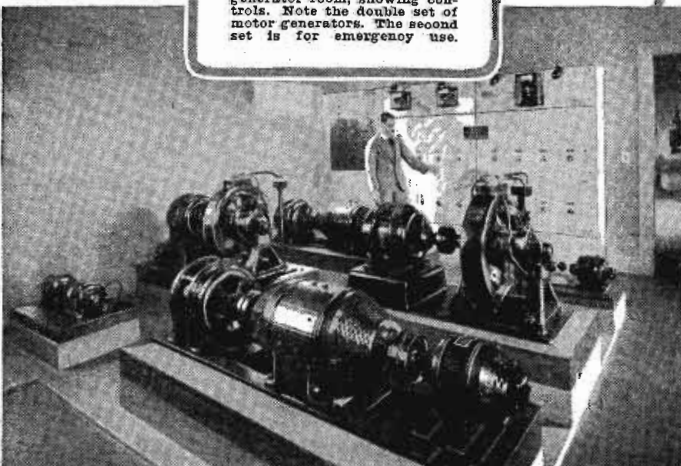

The new towers at KFI pointing up into the California sky 225 feet. The rooms on the roof, house the Radio department. These towers can be seen for miles and are well-known landmarks.

# A Dream of Earle C. Anthony, Los Angeles

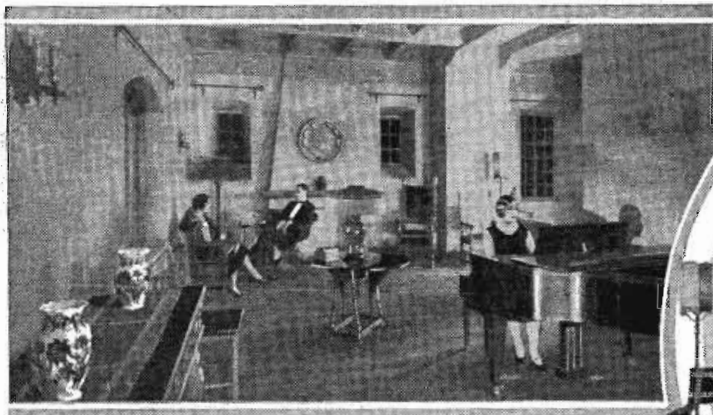

Another view of the supplementary studio. The window on the left is the one through which the activities in the main studio may be viewed.



Supplementary studio at KFI. Two loud speakers are hidden in the walls to furnish music to waiting artists.

A feature of the superset are the four 10,000-volt rectifying tubes. These tubes have a special aluminum jacket through which cooled water flows continuously while they are lighted. Should the temperature of the water rise much above normal of 100 degrees, or the water pressure vary, a thermostat automatically shuts the set down to prevent damage. Likewise, it is impossible to start the set until the water is circulating around the tubes.

On a desk near the main panels sits the finest super-heterodyne receiver made with which it is hoped to do some experimental rebroadcasting of eastern stations. The control room is next to the transmitter room and the operator handling the remote control board can watch through a plate glass window and signal to the engineer handling the main panels. The switchboard and generator room flank the transmitter at the other end. To insure continuous programs under any condition the generators and pumps are in duplicate. In case of breakdown of a unit it is merely the matter of a split second to put another into operation.

A step from the control room is the office where a good-sized force is kept busy sorting, classifying and answering the mail, which amounts to over 1,000 letters daily. It is the nerve center of the station, but to say that Mr. Kales and Carl Haverlin, the able publicity and advertising men of the Anthony organization, are nervy would be unkind. At a desk in one corner Paul Reese, the studio director, holds forth, and close by F. N., Fred Norton, is spending his spare time in patching up a program that caught the heebie-jeebies at the last minute.

As you go along there is a realization that all this equipment has meant a lot of painstaking work and detail, but it is not until the studio doors are opened that one begins to realize the time, expense and care it has taken to make the present KFI from the humble start of only three years ago. For it is the studio, after all, that makes the impression upon the artist and it is this vague thing called "atmosphere" that so vitally effects the brilliance of a song or solo as it is sung or played before the lifeless microphone.

Like a breath from the past is KFI's studio. In keeping with the traditions of old California, the decorations and furnishings are reminiscent of the time when the padres founded their tiny settlements on the brown California hillsides and bulldozed their adobe missions that still stand well-pre-

(Turn to page 6)



Doors leading from reception room to the studios. A doorman keeps visitors out while artists are broadcasting.



Paul Reese, popular announcer and program director of KFI. He is the author of many popular songs.



View of the main studio at KFI. Many renowned artists have broadcast from this studio while in Los Angeles, which is furnished in old Spanish style.



In a land where dance orchestras are numerous, the Paokard Six of KFI has always been known as one of the best.

### Sensational Circuit Disclosure!

**DURING** the past few weeks important advances in Radio have been developed that will effect the ENTIRE RADIO INDUSTRY — will increase range and volume to a degree heretofore not even approached. Working independently, three well-known authorities have been experimenting with Tuned Radio Frequency and have reached the same logical solution.

Radio Digest "scooped" the world by securing first and exclusive information on the work of all three—the work which will be embodied in next season's receiving sets. Manufacturers have paid unbelievable sums just to look at the circuits before contracting for a license. Many have tied up with these engineers and are planning their 1925-26 production on this

revolutionary advance in circuits. To present this development that all our readers may understand it, we have arranged with M. A. Gurney, known to all in the industry as "Milo," and famous for the Miloplex group of sets, to write a series of articles taking our readers clearly and logically through the history of Radio frequency amplification into this new stage. Working constants and data for experimentation will be given and, later, a series of articles on the construction of a set.

Be sure to get the issue of May 30! Save it. Then get the following issues. You will then have the complete advance story on one of Radio's greatest forward strides—yon will know what is in the sets that lead the field next fall. Better results on fewer tubes.

### RADIO PHOTO RECORD

(Continued from page 1)

trans-Pacific Radio-telegraph station at Honolulu. Here the electrical impulses were converted to Radio signals and transmitted across the Pacific ocean to a receiving station in San Francisco. From this point the impulses were sent by land wire to the transcontinental Radio-telegraph station at Bolinas, near San Francisco bay, which station sent the picture impulses across the continent to Riverhead, L. I., receiving station of the Radio Corporation of America. At this point the impulses were again put on land wires to New York city, where the pictures were transcribed on the special device which turned the tiny electrical impulses into light rays to which a photographic plate was exposed.

In the three land wire and two Radio jumps, the apparatus was untouched by human hands, the receivers and transmitters relaying the pictures automatically.

At the Broad street office of the Radio Corporation, a score of newspaper men and scientists breathlessly awaited the test. At its conclusion their awe will be

long remembered. The longest Radio photo transmission had been successfully accomplished. The Pacific ocean and the United States had been bridged by the new invention.

The spectators were enthusiastic over the accomplishment.

This is the severest test to which any picture transmission system has ever been subjected. A year ago the Radio Corporation of America sent pictures with success over a loop from New York to London and return. That was a shorter distance and it was practically all over water. The Honolulu to New York feat included a 2,550-mile overland lap.

### KFI—LOS ANGELES

(Continued from page 5)

served in that beautiful land. The somberness is broken somewhat by flashes of Chinese carved work and screens, but the main motif is that of California at the time of the Spanish conquistadors.

A novel type of receiver has been made by a fan in Glasgow, Scotland. It consists of a crystal set disguised as a barometer.



Above are two of a series of photographs flashed by Radio in twenty minutes each from Honolulu, Hawaii, to New York city. The record-breaking feat spanned a distance greater than 5,000 miles. Fast boats combined with air mail plans would have required ten days at the best to bring the pictures from Hawaii to New York. The top picture is of one of the large Hawaiian defense guns, and the lower is—can you guess?—a line of doughboys taking mess at the field kitchen. The photographs are reproduced here exactly as received. No retouching was permitted!

# Standarddyne

## THE CHOICE OF NEW YORK'S MOST FAMOUS HOTEL!



The BILTMORE HOTEL  
New York

Send for literature descriptive of both Standarddyne models and details of Hotel Biltmore installation.

Name.....  
Street.....  
City..... State.....

The new Standarddyne Receiver, Console Model B-H is delighting Biltmore Hotel guests with its beauty, clarity and distance performance. The radio public will receive it with the same enthusiasm.



WITHOUT ACCESSORIES  
CONSOLE MODEL B-H  
\$125.00



5-Tube Tuned Radio Frequency Standarddyne

\$60  
WITHOUT ACCESSORIES



MANUFACTURED BY  
The Standard Radio Corporation  
41 Jackson Street  
Worcester, Mass.

# Operating and Trouble Shooting

## For the Owner of Radiola X

**T**HE Radiola X Receiver using four WD-11 tubes is a complete Radio receiving set with self-contained loud speaker and provision for internal batteries, mounted in an attractive mahogany cabinet. It contains everything necessary for operation, except the antenna and ground connections and the necessary batteries. Its design permits one to cover the entire broadcast band and it will tune to all wave frequencies between 1400 and 540 kilocycles, 220 to 550 meters.

The circuit employed is the newly developed Regenoflex circuit, designed to eliminate radiation, and also to give selectivity to a degree unapproached by the usual antenna type of receiver.

**Equipment**

Radiola X is completely equipped with tubes but it will be necessary to purchase batteries additional, besides the antenna and ground wiring. The A, B and C batteries obtained should be as follows: A battery, six 1½-volt dry cells, such as Burgess Radio A Dry Cell No. 6, Eveready Radio A Dry Cell No. 711, Manhattan Red Seal Dry Cell No. 2445, Ray-O-Vac Radio A Dry Cell No. 1211, or any other make of good dry cell having a diameter of 2½ inches and a height not exceeding 6¼ inches and having screw and thumb nut terminals.

The B battery should consist of four 22½-volt units connected in series of any of the following: Burgess No. 5156 B P Plate battery, Eveready No. 768 Plate battery, Ray-O-Vac No. 5151 B P Plate battery, or any other good make of Radio B battery whose base dimensions do not exceed 4¼ by 2¾ inches. Leads are arranged for intermediate size batteries with lead and binding post as listed above. Other intermediate size batteries may be used or some of the new vertical types such as Eveready No. 764 and Burgess No. 5153.

Only one C battery unit is necessary and should be Eveready No. 771 Grid battery, Ray-O-Vac No. 231-R Grid battery, Burgess No. 2370 Grid battery, or any other good make of three cell battery, whose dimensions do not exceed 4 by 1¾ inches.

**Antenna**

**Outdoor Type.**—In general, best results will be obtained with an outdoor antenna,

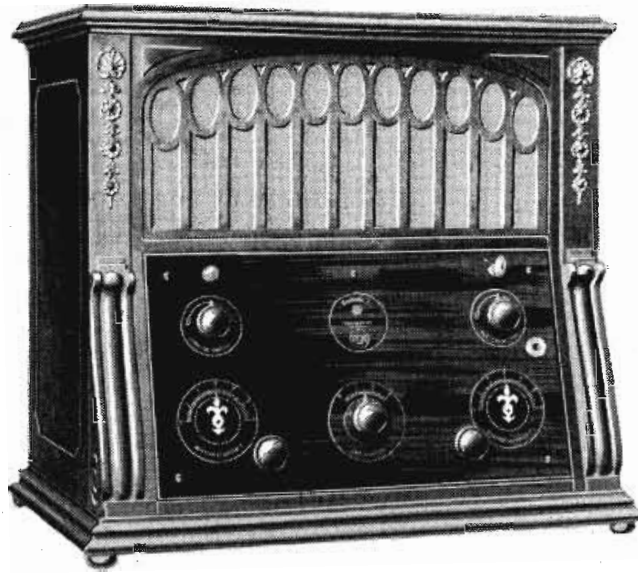

from 75 to 150 feet long, including the lead-in wire, and from 20 to 35 feet above the ground. If the suggested length and height cannot be secured, approach them as nearly as possible. So far as it is possible, the antenna should be located in a space above the tops of surrounding buildings and trees. It should not be touched by any object except the antenna insulators. The same precautions apply to the lead-in wire which should be a continuation of the antenna wire without any joints, and should run as directly as possible to the receiver. The antenna should be at right angles to electric light, traction, power and other wires which

may cause objectionable noises. If practicable, the antenna should be at least 15 feet distant from such wire lines and other aeriels.

Outdoor aeriels having a length up to 150 feet should be used since louder signals and greater distances can thus be secured. Proper volume control and selectivity will be obtained by adjustment of the "Volume Control" knob, regardless of the size of the antenna, provided the length does not exceed 150 feet approximately.

**Indoor Type.**—For local reception, satisfactory results may be secured by using only 20 to 30 feet of ordinary double cut-

ton covered bell wire, No. 18 B. & S., strung around the picture moulding. It may also be run the length of an attic. Such an antenna will not be satisfactory in a building with a metal lath under the plaster. A loop aerial can be used for nearby local reception.

**Ground**

A good ground is as necessary as a good antenna. Perhaps the best ground is a good electrical connection to a water pipe. If this is not convenient, a connection to the steam or hot water heating system will serve unless there is a bad joint in the piping. Connections to gas pipes should not be used. If nothing of this nature is available a pipe or metal rod may be driven into the ground to a depth of several feet, preferably where the soil is moist. The ground connection should be made with a ground clamp, the wire being soldered or held by clamping under a screw or nut. Be sure to scrape and clean the pipe thoroughly before attaching the ground clamp. Usually, connecting to more than one ground, for instance, to both water and steam pipes, will improve reception.

**Operation**

**Volume Control.**—The control so marked serves to regulate the transfer of energy between the two tuning circuits. Thus it regulates the strength of the signal. It also governs the selectivity of the set, that is, the further the "Volume Control" is turned toward the left, the more easily can various stations be separated.

**Battery Setting.**—The control so marked serves to turn on and regulate the current to the filaments of the tubes. When the set is not in use, either the lock directly above this control should be in the locked position with the key vertical or else the pointer of the "Battery Setting" should be turned as far to the left as possible. When it is desired to operate the set, unlock it and then turn the "Battery Setting" pointer until it rests on the mark diagonally upward to the right. With new dry cells in the A battery, this adjustment will give the proper current through the filaments. As the cells become old, it will be necessary to turn the "Battery Setting"

(Continued on page 20)

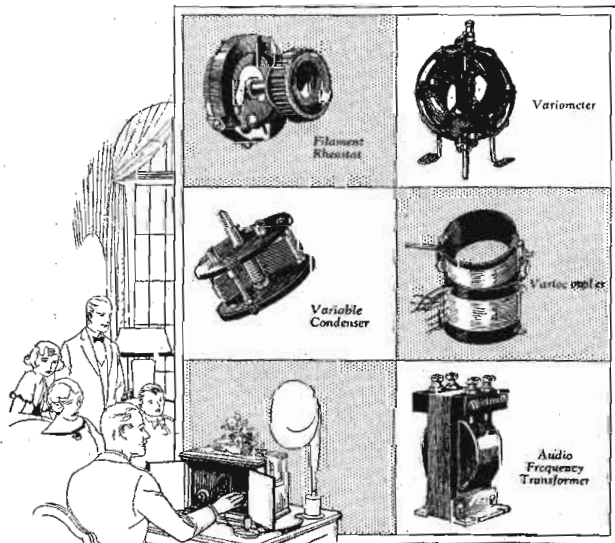

### Quality Parts Matched for Perfect Teamwork

Your "pec" hook-up needs first quality parts—perfectly matched—to give you real radio.

Every Federal Standard Radio Part is designed, made, matched and guaranteed by Federal. That is why you find Federal parts in all the better hook-ups—that is why you should insist on Federal parts when purchasing.

FEDERAL TELEPHONE MANUFACTURING CORP  
Buffalo, N. Y.



# Federal

Standard RADIO Products

## Every word as clear as crystal

Patent Pending  
For Best Results  
Buy only Genuine  
**SHAMROCK-HARKNESS**  
Licensed Parts

The Shamrock Kit contains only these genuine, guaranteed parts.

Also Ask to See the Improved  
**SHAMROCK-HARKNESS**  
**THREE-TUBE COUNTERFLEX**  
The Wonder Set **\$39.50**

**PRICE \$35**

**SHAMROCK MANUFACTURING CO.**  
Dept. 310, Market St. Newark, N. J.  
**SHAMROCK**  
FOR SELECTIVE TUNING  
The set for the masses as well as the classes

SHAMROCK MFG. CO., Dept. 310, Market St., Newark, N. J.  
Please send me a copy of "Shamrock Radio Builder's Guide Book" containing diagrams and complete instructions for building 10 sets at prices ranging from \$16 to \$50. I enclose 10 cents (U. S. stamps or coin.)

Name \_\_\_\_\_  
Address \_\_\_\_\_

















An Evening at Home with the Listener In

(FOR CENTRAL TIME)

(FOR EASTERN TIME Or Cities Using Central Daylight Saving Time)

Table with columns: Call, Saturday, Sunday, Monday, Tuesday, Wednesday, Thursday, Friday, Call, Location, Met, Saturday, Sunday, Monday, Tuesday, Wednesday, Thursday, Friday, Call. Lists radio stations and their broadcast schedules.

# Radio Digest

PROGRAMS  
Illustrated

Published by the Radio Digest Publishing Company, Inc.  
510 North Dearborn Street  
Chicago, Illinois  
Telephones: State 4372, 4373, 4374, 4375

E. C. RAYNER, Publisher

Eastern Office, Park-Lexington Building, 247 Park Ave.,  
New York. Telephones: Ashland 8144, 8145, 8146

Member of the Audit Bureau of Circulations

241  
PUBLISHED WEEKLY

SUBSCRIPTION RATES  
Yearly in U. S. and Possessions and Canada, \$5.00  
Foreign postage, \$1.00 additional. Single copies, 10 cents.

Vol. XIII Saturday, May 23, 1925 No. 7

## Give Us a Law and Funds

FLOODS of "Consensus of Opinion" voting blanks are being returned but it will take a cloudburst of them to float congress into immediate action for the relief of Radio broadcasting. Two things are needed badly—a modern set of laws for the administration of Radio and an appropriation about four times as large as has ever been passed for the use of the Radio section of the Department of Commerce.

Given some sort of law, and ample funds with which to enforce it, broadcasting cannot help but be improved at least somewhat. As it is now, Radio is aimlessly drifting about, wherever the current chooses to take it. Secretary Herbert Hoover and leaders of the industry are endeavoring to attach a few rudders to the good ship Radio, and have succeeded, within their present limitations, in keeping the boat from going aground.

But shoals are ahead, and it is going to take congressional action to keep the boat afloat. Radio cannot go on indefinitely in its present fashion. Troubles of the worst kind have made themselves known, and are already a nuisance.

Let us have a law. Let us have funds to support the law. The law may be weak in some respects. It may not accomplish all that may be desired, but on the whole, a bad law is better than none at all.

R. P. Crawley accompanies his "Consensus of Opinion" vote with an admirable suggestion for remedying the situation. Mr. Crawley knows Radio, has travelled the country selling sets, and has made good use of his time observing conditions and what is needed. His plan will go to Washington. Like many other good ideas submitted, it may contain the germ of the future law.

Remember, Radio Digest is not entirely "sold" on the Kintner plan. All Radio Digest wants is SOME sort of "rudder" for the good ship Radio. Every idea is welcome, and will be considered from all angles. When the final plan is selected and endorsed by the fourth Radio conference, the result will be a combination of the best points offered by the most practical thinkers on the subject.

Urge your friends to fill in "Consensus of Opinion" votes. If your Radio club meets soon, get a supply of voting blanks from Radio Digest. A big task awaits all who are in favor of relieving the air of its present congestion.

## The Ads Will Tell Us

TURNING over the pages of our morning daily paper our eyes were attracted to an advertisement of a certain brand of cigarette. "Stand By for a —" the ad began. It was illustrated by the picture of a popular New York announcer and included the testimonial of that announcer for the brand of cigarette.

So begins the new era of Radio hero worship. The era has been going on for some time, but at last advertising copywriters are beginning to take heed of it.

For years we have been reading advertisements which tell us that various Ethel Barrymores of the stage and Mary Pickfords of the screen have used so-and-so's beauty cream. Now we are to learn in what kind of suspenders our favorite male Radio stars place their faith. No longer shall we be in doubt as to the manufacture of the chewing gum our microphone favorites chew. No sirree! The ads will tell us.

## Keeping Youth on the Farm

BESIDES benefiting the farmer economically by supplying him with first hand market and weather reports, broadcasting is destined to solve another of the farmer's many problems, that of keeping young men and women on the farm. B. B. Jones, of the Wisconsin department of markets, recently observed the entertainment value of Radio as a strong attraction for youth on the farm. He went further to declare that the farmer is the greatest benefactor of Radio.

Mr. Jones is right. Radio, like the automobile, is doing much to entrench the farmer in the strong and contented position that he once occupied before the day of mass production, when so many of his sons and daughters left the farm to enjoy the diversions of metropolitan life.

## RADIO INDI-GEST

### Introducing Mike and Izzy

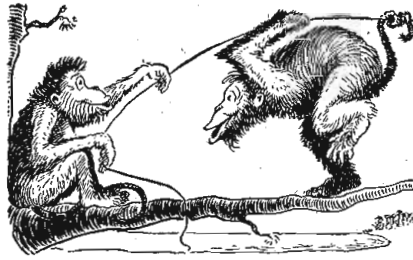

Friends and readers of Indi-Gest, meet Mike (left) and Izzy (right), trained antenna raiser chimpanzees, for the great Walla Walla Station ELAH. Inasmuch as our contributors failed to contribute enough printable and sad jokes to fill the column this week, we were asked by Mike and Izzy if we would give them a little free publicity. As was remarked in a previous issue, they are very intelligent, both having been fired from Harvard zoo on the same day, less than three feet apart. After seeing the above picture, they said indignantly, in chorus: "Why, you've made monkeys outa us!"

Another cute thing that they do (see picture) is to hold onto the aerial wire with their tails. Asked why they did this, Izzy replied, "The matter has been called to my attention that you print your paper, Indi-Gest, on a rotary press and print over 200,000 copies, so I didn't want to fly off the roller." Mike had a much more simple explanation. (He is very simple.) He answered, "I just had a temporary ether wave put in my tail, and I didn't want to change the wave length."

To prove their excellent education, listen in on the following conversation:

Mike: "Who invented Radio, anyhow?"  
Izzy: "Macaroni, but not anyhow. He just invented it."  
Mike: "Why, oh why, did he do it?"  
Izzy: "Because he had a corner on the spaghetti tubing market and wanted to round it off."  
(Curtain)

All of which goes to prove they don't know anything.

Max: "Why are all Radio fans idealists?"  
Climax: "'Cause they're always looking for a better earth!"

## The Radio Dictionary

To keep in style, 'tis well these days  
To be a shark at words.  
With cross-word puzzles has evolved  
These dictionary birds.  
They sit cross-legged on a ebar,  
With forehead in a knot,  
Their horizontal, vertical,  
A mess all polyglot.

A "biped"—that is m-a-n,  
Three letters,—t must be right!  
"Simlan"? What on earth!  
O, yes!

An a-p-e! How bright!  
And so this dictionary bird  
Learns "earnel," "dromedary,"  
And adds a learned hump or two  
To his vocabulary.

But when trilateral words run out,  
Long words you'll need to know;  
When Webster's is all learned by heart,  
They'll turn to Radio  
"Condenser," "variometer,"  
"Transformer," "amplifier,"  
"Potentiometer,"—that word  
Should set a world on fire!

And "variacoupler." Look it up,  
Or ask some Radio fan;  
"Grid-leak"—a capsule made of glass,  
To tempt the heart of man,  
Then "vacuum tube" and "rheostat,"  
"Inductance coil" and "dial,"  
"Regeneration," "binding post,"  
Just take them single file.

If you would be a "Radio bug,"  
From "aerial" to "ground,"  
You'll learn to throw these Radio words  
And phrases freely 'round.  
Don't mix your definitions,  
Lest static spoil your chat!  
They'll say your station's N. G., for  
You broadcast through your bat.  
BERNICE CLANCY MARTIN.

## Better Luck Next Time, Doctor!

Dear Indi: Following Sir Oliver Lodge's sensational statement that the human eye is in reality a Radio set comes the claim of Dr. Russ, a famous London surgeon, to have perfected a sensitive instrument which is influenced by the power of the "ray" from the human eye. Dr. Russ declares his instrument is so sensitive that not even a concentrated gaze is necessary for it to be stimulated into motion. Apparently one just hands it the glad eye, and round swings the indicator. Unfortunately for the learned doctor, his discovery of this "T" ray and his invention of a sensitive instrument which responds to it are by no means new. A glance from the female human eye was known to cause a movement in the sensitive male heart even as long ago as the days of the Garden of Eden!

HEART DOCTOR.

Son: "What nationality is a child born in the U. S. A., whose father is French and mother Italian?"  
Father: "American, of course, my boy."  
Son: "Well, how about my family of Kittens born on the roof. Are they aerials?"  
A. C. B.

## Call in the Doctor



## Condensed

By DIELECTRIC

Not all the protests of listeners in go for nothing. Many of us were of those who tuned in church services after the station had announced its call and turned to the funny sheets, while we tried to guess the identity of preacher and congregation. I was a late attendant by Radio of a church service one Sunday where the pastor paused to state that we were hearing a Methodist service through Station KDKA. Other ministers would confer a favor on Radio listeners by emulating the example of the Pittsburgh preacher.

When the dials are set for Station KTHS, Hot Springs National Park, Ark., you are apt to find that station in the midst of a program given by the Arlington orchestra. If it is, then sit back for a joyous time. This is one of the really good orchestras rendering selections both classical and semi-classical and, at the appropriate hour, enticing dance numbers. Other features are also attractive.

There was some banjo playing in the studio of WLW Cincinnati, above the average of modern banjo work. Imitation of the style of other instruments robs the banjo of its characteristic effects, yet that is the popular thing at present. Solo and duet numbers were offered in the original, captivating style and merit our applause.

In the search for something new under the sun, program managers of many stations are presenting all kinds of novelties for the entertainment of the fan. The Hollywood movie station, KFWE, solved their problem very easily by inducing well-known stage and screen favorites to act as announcers. The station motto or slogan might well be "A different personality every evening." As a rule the acting fraternity seem to make good before the "mike," their training giving them the necessary poise, precise pronunciation and knowledge of showmanship that goes a long way toward making the successful announcer. Patsy Ruth Miller, however, did not go over so well. Taken as a whole the mcn do make better announcers.

Possibly many of you are familiar with the Ethiopian Rhapsody as a composition, but fewer perhaps with the piece as interpreted by the Reo orchestra, playing through Station WREO, Lansing, Mich. I was sorry when they had completed the number. Mr. Severn's violin playing was quite agreeable. In fact there is only commendation for WREO.

From WGBS, New York city, a unique feature was presented in the form of an entertainment from the steamship Leviathan—direct from the ballroom of this immense vessel. Among those taking part were a soprano and pianist, gifted musicians both, and their immediate audience comprised many notable people of the two hundred present.

WNAC, Boston, gave a description of a prize fight one evening. There was nothing out of the ordinary in the scrap itself; neither fighter had a reputation to excite awed interest. The most noticeable thing about listening to this station's program was the nest of other stations all around the one wave length. Here is your evidence of overloaded air. Many stations should be given space in these columns not now receiving any, but until the air is cleared it is unlikely they can be heard. Other stations buy the American Telephone's advertising specialties several nights a week, so if you turn north, south, east or west, it's the same old thing with a different mike, that's all.



# Goodrich Four Tube Dry Cell Semi-Portable

## Compact, Doubly Regenerative and Easy to Construct

By W. M. Goodrich

THE receiver about to be described is the result of an effort to approach super-heterodyne range with a limited outlay of money and a strong desire to get away from storage batteries with their attendant troubles and muss.

To get these results, the first effort was one stage of tuned radio frequency ahead of a regenerative detector. This was good and added both to volume and selectivity. This last characteristic is about the most desirable feature a Radio receiver can have these days. As a further step towards economy, reflexing at the first stage at audio frequency through the R.F. tube was tried. Results were erratic. So many factors seemed to enter into the successful operation of this ar-

Volume was good, but there was not "dancing intensity" from the coast stations by any means. More amplification was needed and it looked as if one more tube would have to be placed in the set, with the preference given to another stage at R.F. In any event, one more tube would place the set where three dry cells would not be economical, and that was a condition not wanted.

The decision to make the R.F. stage regenerative was made after watching a "super" working on a regenerative loop. The loop is in the grid circuit of the first tube (in the super), so why not make the grid circuit of the set in question regenerative and enjoy the same added selectivity and sensitivity? Right here, the most

had without ever running close to the point of oscillation in the R.F. tube. Also, if the specified number of turns are used in the primary of the coupler, oscillations in the detector tube will not "show through" the R.F. amplifier.

wire of the primary should be directly under the first wire of the secondary. Provide mounting legs that will keep this coil about one inch above the baseboard.

When winding the second coupler keep in mind that all three windings, the pri-

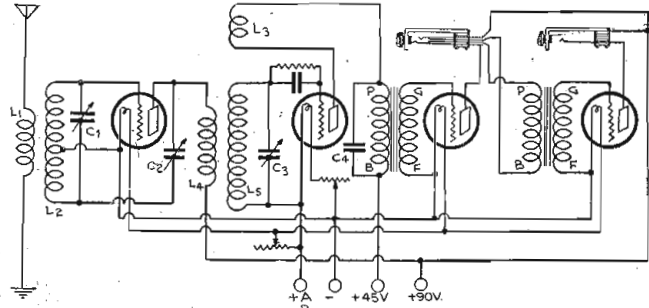

- L-1 is .0005 mfd.; C-2 is .000045 mfd.;
- L-2 is 54 turns No. 20 dsc. on 3" tube.
- L-3 is 12 turns No. 28 dsc. on 2" rotor.
- L-4 is 8 turns No. 28 dsc. on special form.
- L-5 is 54 turns No. 20 dsc. on 3" tube.
- C-3 is .0005 mfd.; C-4 is .002 mfd.
- L-1 is 16 turns No. 20 dsc. on 2 1/4" tube.

regeneration that it was abandoned. Now, with good tubes as cheap as they are, it looks like false economy.

### Regeneration Is Decided Upon

Further improvement was desired at this point, although four 193 tubes, used in one stage R.F., regenerative detector and two audio, gave wonderful results:

of you say, the set will be a bad offender with radiation.

It is, with improper handling. So will a super-heterodyne on an aerial, or any neutrodyne not entirely neutralized on all wave lengths. This set has a loose-coupled primary, and further, the greatest distance, volume and selectivity can be

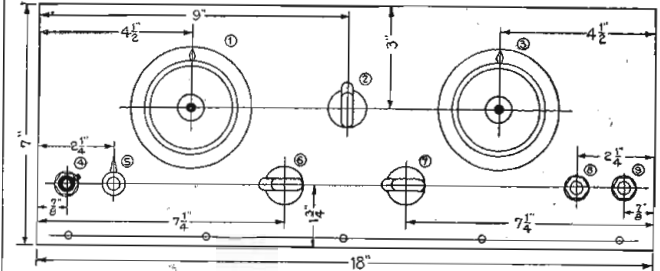

The shorter 3" tube is used for the secondary of the R.F. coil. Start the winding about one-half inch from one end, leave a tap at the center turn and the winding will finish about one-half inch from the other end. Locate the terminals and tap as shown on the "Baseboard Layout," when you wire up. "G" goes to the grid of the R.F. tube and the stator plates of the condenser. "F" goes to the negative A battery lead and to the rotor plates of the condenser. The same instructions apply to the coupler secondary winding terminals with this one exception: "F," which is the lower one, goes to the positive A battery instead of negative. This is important. The reason for this detail of the terminal layout is to permit the shortest possible grid leads.

### Winding Primary of Coil

The 2 1/4" tubing, 1 1/4" long is for the primary of this coil. This is mounted concentrically in the left end of the secondary form in any convenient manner. Bring the terminals out as shown; the inner end is the aerial side. When locating the primary in the secondary, the first

primary, secondary and rotor are in the same direction. Start the secondary 1/2" from the bottom of the tube and it will finish up about 3/4" from the top. The primary form can be made of bakelite, hard rubber or hardwood, preferably mahogany or walnut. If made of wood it should be dipped in boiling paraffin to exclude moisture, before winding.

The terminal screw for the lower end of the secondary should be flat head countersunk to allow free entrance of the primary form. The primary is wound, in any fashion in a groove about 1/8" square. This groove should lie under the first two turns of the secondary.

In winding the rotor, start the winding as close to the edge as possible, wind six turns, and skip over to right spacing on opposite side, so as to finish close to the edge. The idea is to leave maximum clear space in center for placing two small brass screws used as terminals for this winding.

In wiring up use small flexible "pigtail" wire direct from these terminals to the

(Continued on page 18)

"Last night we heard the sweetest voice!"



FEW boast of having heard a powerful voice. Radio has grown up. It is now something to listen to, not to marvel at. We are now in the cycle of TONE!

The other day a man said he was just realizing that he had a hundred dollars worth of set and a dollar's worth of horn! His next move is to balance up his set with a good speaker.

The BRISTOL has all the volume you will ever want, but its fine point is TONE. It is good to listen to. The notes come in in tune. You receive a wealth of music from which the cream of tone has not been skimmed.

For \$20, \$25 or \$30 you can get a Bristol Speaker, and there are others for less. Ask your dealer to send one out to the house. And let us send you folder No. AY-3022; it tells why the Bristol is the horn of tone.

**BRISTOL** AUDIOPHONE Loud Speaker  
THE BRISTOL COMPANY, WATERBURY, CONN.

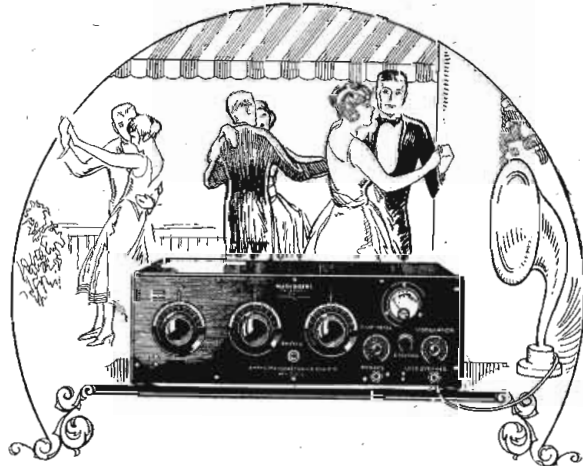

### More Useful Improvements—

THE Improved MARV-O-DYNE, model 612-C, has more really useful improvements than any other set at any price. To you that will mean clear and better reception over greater distances.

What other set offers you the Fil-a-meter? This exclusive device works in conjunction with a genuine Weston meter and keeps the tubes always at their best operating point. The saving in tubes and batteries is obvious.

And as for tone quality—well, a demonstration will surprise you. MARV-O-DYNE speaks right up; it never mumbles. Stromberg-Carlson transformers see to that.

Before you decide on any set, be sure to go to your dealer. Look over the nationally known units of which this set is built. Listen to it. You'll be surprised to learn that the Improved MARV-O-DYNE sells for only \$110.

West of the Rockies and Canada \$120

Amber Manufacturing Corp., 599 Eleventh Ave., New York City



**GOODRICH RECEIVER**

(Continued from page 17)

tube and transformer. In making the supporting legs for the coupler, so proportion their length and so locate them on the base, that the coils are at right angles with each other and at distance from each other shown on the diagram.

a fairly strong signal at the moment, rotate your condensers around about in step, a few degrees at a time, turning the rotor down in the coil at each stop. It should "peep" or "squeal" half way or parallel with the rotor. If not, reverse rotor leads and proceed as before. If not then, check over for an open circuit, poor tube contacts, defective grid condenser and leak.

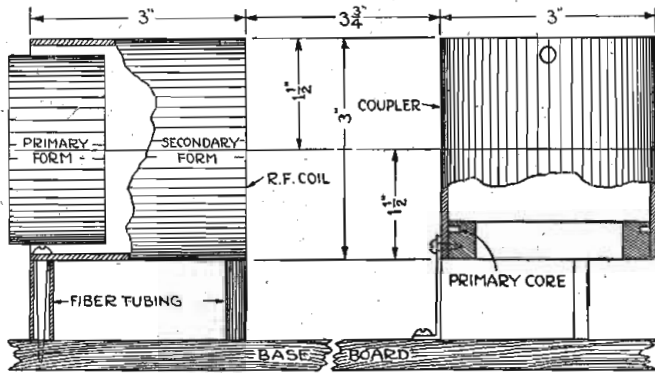

The center line, or axis, of the R.F. coil, if extended must pass through the exact center of the coupler on the middle turn of the secondary windings. If the coils are not so located, you probably will be bothered with uncontrollable "squeals."

**Mounting Transformers**

In preparing to mount your transformers notice that they are directly under the detector and audio tubes. See if your transformers are low enough in height to permit putting the set in a cabinet. If not, cut out a section of the base and support them on strips on "stirrups" to gain approximately the thickness of the baseboard in your overall height. Other arrangements will also be found feasible. Locate the second audio transformer as far to the right as possible, and locate the first one at right angles to it and at least one and one-half inches from the coupler.

Connect the shields to the negative "A" filament. This is in lieu of grounding them. The last three tubes, detector and audio must be cushion mounted; the R.F. tube does not have to be cushion mounted. At the risk of being criticized for repeating, we will repeat, arrange your tube sockets and transformers for shortest possible grid leads. Also keep grid leads as far

**Tuning of Finished Receiver**  
In tuning, handle as any regenerative receiver, the strongest signals and greatest selectivity with your regeneration just below the "spilling over point."

However, if you will leave your "midget" condenser at its lowest capacity you can locate your station by the "squeal" without any trouble or aerial radiation, then reduce "squeal" to voice or music and then strengthen and increase selectivity, if needed, with the "midget" condenser.

**LIST OF PARTS**

|  |                |
|--|----------------|
| 1 Panel, 7x18"                             | \$ 3.15        |
| 2 Variable Condensers, .0005 mfd.          | 10.00          |
| 2 Vernier Dials                            | 5.00           |
| 1 Midget Condenser, .000045 mfd.           | 1.50           |
| 1 Battery Switch                           | 1.00           |
| 1 Rheostat, 30 ohms                        | 1.00           |
| 1 Rheostat, 20 ohms                        | 1.00           |
| 2 Audio Transformers, shielded, 3 1/2 to 1 | 10.00          |
| 1 Jack, double circuit                     | 1.00           |
| 1 Jack, single open circuit                | .70            |
| 1 Grid Condenser, .00025 mfd.              | .40            |
| 1 Grid Leak Cartridge, 3 to 5 mgrs.        | .50            |
| 1 Fixed Condenser, .002 mfd.               | .60            |
| 4 Tube Sockets, 199 type                   | 1.00           |
| 1 Piece 3" tubing, 2 1/4" long             | .30            |
| 1 Piece 3" tubing, 3" long                 | .30            |
| 1 Piece 2 1/2" tubing, 3/4" long           | .10            |
| 1 Piece 2 1/2" tubing, 1 1/4" long         | .20            |
| 1 Pound No. 20 disc. wire                  | 1.50           |
| 1/4 Pound No. 28 disc. wire                | .90            |
| Miscellaneous screws, wire, etc.           | 2.00           |
| 1 Cabinet, 7x18x7"                         | 8.00           |
| 1 Baseboard, 8 1/2 x 17"                   | .90            |
| <b>Total cost</b>                          | <b>\$51.35</b> |

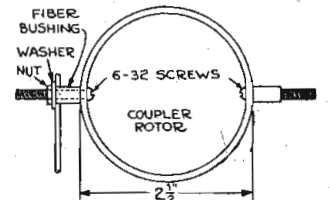

from plate leads as you can, as nearly at right angles thereto as possible, and never parallel.

In mounting your instruments on the panel, take a good look at your "midget" condenser. A short circuit here will introduce your tube filament to the B battery. I don't ever remember of any such meeting being profitable to anyone but the tube dealer.

Aerial and ground binding posts are not shown on the drawings. They can be located as usual on front of panel or plate

On a great many stations it will be left at about one-third of its capacity. The two condenser dials go around just about in step. The right hand is the more critical. The set logs the same on any station every time on any aerial. As you use the set you will notice the amplifier rheostat controls to a slight degree regeneration in the R.F. tube; also, that the "Midget" condenser affects the setting of the left-hand dial on any given station.

This set properly constructed is in every way equal to any five-tube neutro-

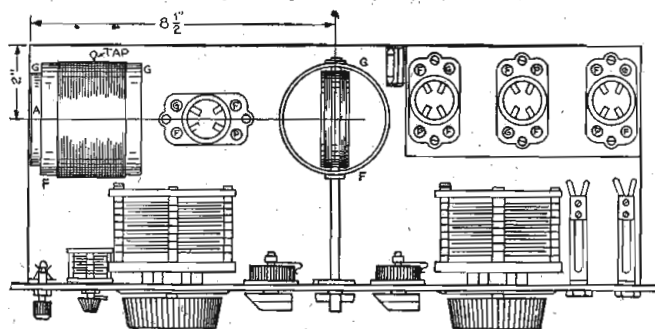

on a small strip of hard rubber or bakelite, supported from the back edge at the baseboard and bringing them up pretty well above the R.F. coil. If the binding posts are placed on the front of the panel, locate the "G" terminal on the front side of the primary form instead of the rear as shown, which was intended for rear mounting.

After winding up and giving it the usual double check-over, after getting ready to operate, make sure that the detector tube will oscillate. If not possible to try it on

dyno provided quality of material used and quality of workmanship is the same. As a rule, it has better tone and selectivity. A long aerial gives more volume but less selectivity. If near a powerful local, use forty feet, and they won't bother you much.

The 500-watt stations, 500 miles away need only one stage of audio to give you good, "comfortable" loud speaker reception. On the second stage in Kansas City, both coasts, Canada, Mexico and Cuba are good on the horn.

# The NEW Radio Book



**How to understand radio, assemble circuits, improve reception, operate sets,**

**EVERY** phase of Radio reception gathered into one book at last! Explanation of elementary principles, directions for constructing parts, detailed how-to-build articles for the assembly of sets, operating directions on popular manufactured outfits.

Haven't you often wondered what all the spirals, wriggly lines and zig-zag lines were about on diagrams? A big chart shows you a picture of the part as you see it and, beside the picture, the symbol used in diagrams. Other articles show clearly just what happens within the mysterious little vacuum tubes that glow hour after hour within your set, apparently without change, yet pass every note of a jazz orchestra or soprano.

Antennas, for whose erection there are seemingly no rules, are covered fully; the reason for a long wire in some locations and a short one in others, is readily grasped by anyone. Crystal sets, one tube, two tube reflexes, three tube regenerative and reflex outfits, four tube R. F. and neutrodynes, five tube assemblies—all types are presented up to the nine tube "super," king of the air.

**For the Man That Bought His Set**

For the non-technically inclined there is a two-color broadcast map of the country, operating schedules of all the leading stations, call letters and power rating of every station on the air, suggestions for the care of batteries and tubes.

No matter what type of receiver you own, there are dozens of valuable suggestions on tuning, trouble shooting and operating. Your head receivers, loud speaker, antenna and certain parts within the set, require frequent cleaning, adjusting and care. Interference and its remedies are factors you should understand even though you care nothing about "what makes it go."

Compiled by the technical staff of Radio Digest, it represents the big lights of the past twelve months in the Radio field. All this data is indexed for ready reference and logically arranged. Only a few thousand have been printed and this offer will stand for a limited time. The only book of its kind and is FREE with one year's subscription to Radio Digest. This offer good only on subscriptions sent directly to this office, not through agents or agencies.

Subscription Department

## Radio Digest

510 N. Dearborn St., Chicago, Ill.

*free*

Radio Digest 5-23-25  
Enclosed is \$5.00 in ( ) M. O. ( ) Check, ( ) Currency, for which enter my subscription to Radio Digest for one year and send me the book, "Radio Receivers."  
Name .....  
Address .....  
(Type or Print Clearly)

# A. B. C. Course in Radio Fundamentals

## Chapter IX—Action of Inductance and Capacity in Circuits

By David Penn Moreton

A CIRCUIT composed of a resistance  $R$ , inductance  $L$  and a capacity  $C$ , all connected in series, is shown diagrammatically in figure 45. In such a circuit, the current is exactly the same in every part of the circuit at the same time, and this current may be represented by a curve such as the one marked  $I$  in figure 46. The electrical pressure between the terminals of the resistance will be in phase with the current  $I$  through the resistance and it may be represented by a curve  $E_r$  as shown in figure 46. The electrical pressure between the terminals of the condenser will lag the current  $I$ ,

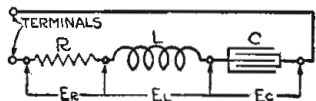

Figure 45

through the condenser, or the current  $I$  will lead the electrical pressure between the terminals by 90 degrees, and this electrical pressure may be represented by a curve  $E_c$  as shown in figure 46. The electrical pressure between the terminals of the inductance will lead the current  $I$  in phase by 90 degrees, or the current will lag the electrical pressure between the terminals of the inductance by 90 degrees and this electrical pressure may be represented by a curve  $E_L$  as shown in figure 46.

### Determining Electrical Pressure

The effective electrical pressure between the terminals of the resistance, as indicated on an alternating-current voltmeter, will be equal to the product of the resistance in ohms and the effective current through it in amperes. If the current  $I$  in figure 46 is a sine-wave current its effective value will be equal to 0.707 of its maximum value.

The effective value of the electrical pressure between the terminals of the con-

denser will be equal to the product of the effective current through the condenser and the reactance of the condenser in ohms. The reactance of the condenser in ohms is equal to one divided by 6.2832 times the frequency, times the capacity of the condenser in farads:

$$\text{Capacity reactance} = \frac{1}{6.2832 \times f \times C}$$

The electrical pressure between the terminals of the condenser is given by the following expression:

$$E_c = \frac{1}{6.2832 \times f \times C} \times I$$

The effective value of the electrical pressure between the terminals of the inductance will be equal to the product of the effective current through the inductance and the reactance of the inductance in ohms. The reactance of the inductance in ohms is equal to 6.2832 times the frequency of the current times the inductance of the coil in henries:

$$\text{Inductance reactance} = 6.2832 \times f \times L$$

The electrical pressure between the terminals of the inductance is given by the following expression:

$$E_L = I \times 6.2832 \times f \times L$$

An inspection of the expression for the value of  $E_c$  shows that  $E_c$  increases with a decrease in the frequency and decreases with an increase in the frequency. An inspection of the expression for the value of  $E_L$  shows that  $E_L$  increases with an increase in the frequency and decreases with a decrease in the frequency. The value of the electrical pressure  $E_a$  between the terminals of the resistance is independent of the frequency of the current through the resistance.

The electrical pressures between the terminals of the inductance and the terminals of the condenser are displaced in phase with respect to each other by 180 degrees. If  $E_L$  and  $E_c$  are equal in value they will exactly neutralize each other and the combined drops across the inductance and condenser will be zero. The total electrical

pressure between the terminals of the circuit will be equal to the value of  $E_a$  when  $E_L$  and  $E_c$  are equal.

When the values of  $E_c$  and  $E_L$  are not equal they may be made equal by changing the frequency of the current in the circuit. If  $E_L$  is greater than  $E_c$ , a decrease in frequency will decrease the value of  $E_L$  and also increase the value of  $E_c$  and for some particular frequency  $E_L$  will be equal to  $E_c$ . If  $E_c$  is greater than  $E_L$ , an increase in frequency will decrease the value of  $E_c$  and also increase the value of  $E_L$  and for some particular value of frequency  $E_c$  will be equal to  $E_L$ .

The values of  $E_c$  and  $E_L$  may be made equal to each other without a change in frequency by changing the values of the inductance  $L$  or the value of the capacity  $C$ . Increasing the value of  $L$  increases

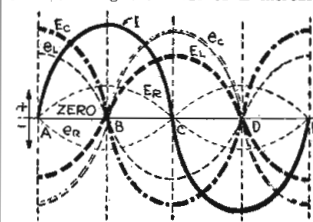

Figure 46

$E_L$  and increasing the value  $C$  decreases  $E_c$ .

If  $E_L$  and  $E_c$  are not equal the current  $I$  will not be in phase with the electrical pressure impressed on the circuit. The current will lead the electrical pressure impressed on the circuit if the capacity reactance is greater than the inductive reactance, and the current will lag when inductive reactance exceeds in value the

capacity reactance. The same relation exists between  $E_c$  and  $E_L$  as exists between the capacity and the inductive reactance.

When  $E_c$  and  $E_L$  are equal, there is said to be a resonance of electrical pressures and the circuit will have a minimum impedance and hence a given impressed electrical pressure will produce a maximum current. The electrical pressure between the terminals of the capacity and the inductance does not bear any definite relation to the electrical pressure impressed upon the circuit, but depends upon the current in the circuit and the value of the reactance of the inductance and the reactance of the capacity. When the inductive and capacity reactances are equal the current is equal to the impressed electrical pressure divided by the resistance of the circuit.

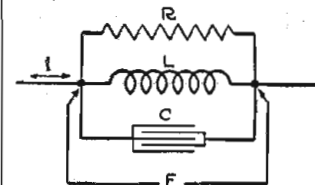

Figure 47

In a series circuit of the kind just described, the electrical pressure between the terminals of the inductance and the terminals of the capacity may be much greater than the total applied electrical pressure.

### Resistance, Inductance and Capacity in Parallel Circuit

A circuit composed of a resistance  $R$ , an inductance  $L$ , and a capacity  $C$ , connected in parallel, is shown in figure 47.

(Continued on page 20)

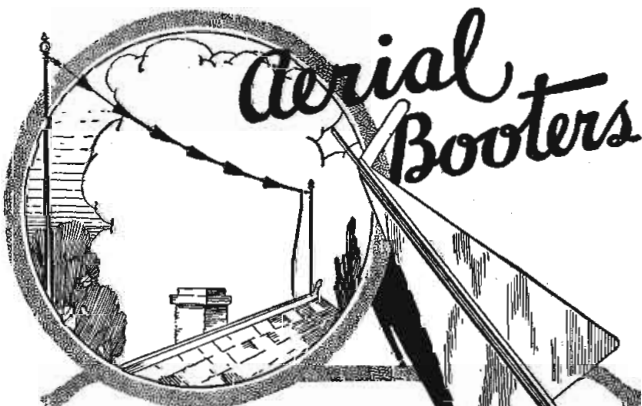

# Aerial Booters

## Something New FOR YOUR AERIAL

- Like to get more distance?
- Like to get greater volume?
- Like to save your batteries?

**AERIAL BOOTERS ARE DOING IT**

Get them from your dealer or send \$1 for set of six and testimonial letters postpaid.

If they don't do what we claim, money will be refunded without question

References:  
Dun's, Bradstreet's or Any Bank.

**Q. R. S. COMPANY. RADIO DEPARTMENT**  
25 E. Jackson Blvd. Chicago Illinois

## pep up your set with good tubes

"HEARIN' is believin'"—so goes an old adage. And if you switch to MAGNATRONS you, too, will agree, because MAGNATRONS do make a difference.

More stable radio frequency amplification, clearer detection, and greater volume—those are the features which MAGNATRONS have to offer. Your dealer sells MAGNATRONS in the DC-199, DC-201A, and DC-199 large base types for only \$3.

CONNWEY ELECTRIC LABORATORIES  
309 5th Ave., N. Y. City Factories, Hoboken, N. J.

# MAGNATRONS

# Now!

SUB-PANEL MOUNTING TYPE  
They permit a neater assembly, shortening of leads and concealing of wiring—as in factory built sets. Same ratios—same prices—as standard type Thordarsons.

|                 |                   |
|-----------------|-------------------|
| Audio Frequency |                   |
| 2 - 1, \$5.00   | 3 1/2 - 1, \$4.00 |
| 6 - 1, \$4.50   |                   |

Unconditionally Guaranteed

# THORDARSON

Super AMPLIFYING TRANSFORMERS  
Standard on the majority of quality sets

Order direct if your dealer cannot supply

THORDARSON ELECTRIC MANUFACTURING CO.  
Transformer specialists since 1897  
WORLD'S OLDEST AND LARGEST EXCLUSIVE TRANSFORMER MAKERS  
Chicago, U.S.A.

**HOW TO OPERATE SET**

(Continued from page 7)

still further to the right. The filaments should always glow at a dull red color, and should never be burned brighter than necessary to obtain volume. They may be examined at any time by tipping the panel forward.

**Station Selector I**—The control so marked serves to adjust the antenna tuning circuit so that it will respond to the desired wave length.

**Amplification**—The control so marked adjusts the regeneration, and thereby regulates the sensitivity and the selectivity of the set.

**Station Selector II**—The control so marked adjusts the secondary tuning circuit so it will respond to the desired wave length.

Turn the "Volume Control" until the pointer extends horizontally to the right. Turn the "Battery Setting" until the pointer rests on the mark, previously described, which shows proper position when batteries are new. Turn "Amplification" until a breathing sound is heard. This should occur when the pointer reaches "2.3" or a little before. If it does not, disconnect the lead marked "420B" from the positive terminal of the first block of the B battery and connect it to the positive terminal of the second block.

**Tuning In Station**

Turn both "Station Selector I" and "Station Selector II" from one end of the scale to the other, keeping them at approximately the same readings all the time. Go slowly and listen carefully. A squeal or whistle will be heard when the set is tuned to a station that is operating. When the whistle is heard, turn "Station Selector I" until the whistle assumes a very low pitch. Then turn "Station Selector I" until the whistle becomes loudest. Finally turn "Amplification" to the left just enough to stop the whistle when the speech or music should be heard clearly. A slight readjustment of "Station Selector II" may be necessary for best results.

Of course, it may happen that a station is found between numbers of its program. Therefore, if nothing is heard at the conclusion of above process, wait a minute or so. Do not wait too long before adjusting "Station Selector II." A whistle may also be produced by an improperly operated receiving set nearby, but such a whistle seldom remains constant.

A little experience in making the adjustment will be necessary before stations can be found easily and quickly, but once

this experience is had, the operation of picking up signals and tuning the receiver is very simple.

**Relation Between "Station Selectors"**

It will be found that there is a definite relation between the two "Station Selectors," for example, when "Station Selector II" is set on "3," "Station Selector I" should be nearly "3" when both are tuned to the same wave length. It may happen that this agreement will not be very close, in which case "Station Selector I" will reach one end or the other of the scale before "Station Selector II," thus making it impossible to tune both selectors accurately over the whole wave length range. To improve this condition, tip the panel forward. At the extreme left is a coil wound on a mica tube. At the top of the coil are four terminals, to one of which is attached a lead from the antenna. Remove this lead and attach it to one of the other terminals. With any ordinary antenna a terminal can be found where the agreement between the "Station Selectors" will be close.

When receiving from nearby stations, it may happen that the volume will be greater than is desired. Do not attempt to decrease the volume by turning back the "Battery Setting" as that will spoil the quality. Turn back the "Volume Control" until the signal strength has been reduced as much as desired. Selectivity, or the ability to pick a desired station out of interference, depends upon the setting of "Volume Control." The receiver is much more selective when this control is turned to the left so that it is often desirable to operate with this control almost to the left limit. This weakens the signals somewhat, but they can be brought up to desired loudness by further adjustment of the "Amplification Control."

**Storage Battery Charger**

A storage battery can be charged only by a direct current, and when charging, the positive wire of the charging current must be connected to the positive of the battery, and the negative to the negative. The voltage of the charging current should be somewhat greater than that of the battery, while the amperage should not be above one-tenth of the capacity. When a battery is charged or discharged very quickly it will overheat and the paste will fall out of the grids. Not only will this prevent the battery from taking a charge, but it will short circuit the plates at the bottom. For this reason the battery must be charged slowly.

**A. B. C. RADIO COURSE**

(Continued from page 19)

nected in parallel is shown in figure 47. In a circuit of this kind the current I in the main line is composed of the three currents in the resistance, inductive and capacity branches respectively. If the three currents were in phase they could be added as in the case of a direct-current circuit, to get the total current; but in the case of an alternating-current circuit the phase relation of the current must be taken into account in obtaining the resultant current.

Since the same electrical pressure acts upon all three branches of the circuit shown in figure 47, we can use the wave of this electrical pressure as our reference curve. In the case of the series circuit we used the current wave as the reference wave since the various parts of the circuit were all in series and carrying the same current.

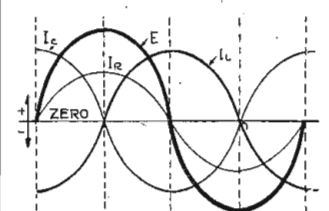

Figure 48

Let the electrical pressure acting on the parallel circuit be represented by the curve marked E in figure 48. Now the current in the branch of the divided circuit composed of the resistance will be in phase with the electrical pressure E and may be represented by the curve I<sub>c</sub>. The effective value of this current will be equal to the effective electrical pressure divided by the resistance of the branch.

**Current Lags 90 Degrees**

The current in the branch composed of the inductance L will lag the electrical pressure E by 90 degrees and may be represented by the curve I<sub>e</sub>. The effective value of the current will be equal to the effective value of E divided by the reactance of the circuit in ohms.

The current in the branch composed of the capacity C will lead the electrical pressure E by 90 degrees and may be represented by the curve I<sub>L</sub>. The effective

value of the current will be equal to the effective value of E divided by the reactance of the circuit in ohms.

The three currents I<sub>c</sub>, I<sub>e</sub>, and I<sub>L</sub> combine to give the current I in the main part of the circuit. An inspection of figure 48 shows that the current in the branch composed of the inductance is displaced in phase by 180 degrees from the current in the branch composed of the capacity. If these two currents are equal in value they will combine to give zero value and the current I in the main part of the circuit will be equal to I<sub>c</sub>. When the currents I<sub>c</sub> and I<sub>L</sub> are not equal they will give, when combined, a resultant current which is displaced in phase from E by 90 degrees and this resultant current will lead E if I<sub>c</sub> is greater than I<sub>L</sub> and it will lag E if I<sub>L</sub> is greater than I<sub>c</sub>. This resultant current combines with I<sub>c</sub> and gives the value of I in the main circuit, which may lead or lag E, depending upon the relative value of I<sub>c</sub> and I<sub>L</sub>.

The values of the current I<sub>c</sub> and I<sub>L</sub> may be made equal to each other by changing the frequency of the applied electrical pressure E, or by changing the value of the inductance L or the capacity C.

The application of these relations and their importance in Radio work will be appreciated when the subject of tuning is discussed.

(Editor's Note.—The next installment of Professor Moreton's series will be devoted to electrical measuring instruments, such as ammeters, voltmeters, wvmeters, etc.)

**Cutter for Spider Web Forms**

It is quite difficult to cut forms for spider web coils from celluloid or thin cardboard. The work can be more easily done if a sharp-edged tool is used. I find the discarded safety razor blades to be quite appropriate. To use these blades successfully some kind of a holder must

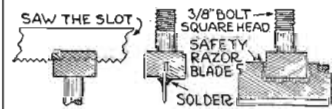

be applied. I made use of an ordinary 1/2-inch bolt having a square head. A slot was sawed in the head to hold the razor blade. The blade is soldered in the slot. The tool is used with a hammer for a driver. The slots can be cut square up to the edges of the form with this cutter. H. H. Yeager, Salina, Kansas.

**CROSLLEY 1-TUBE 50**

\$14.50



The Little Giant of Radio (see our advertisement with pictures frequently reprinted)

**Distance**

on the phones—with certainty and regularity—on the Crosley one-tube 50. The radio which told the world that the MacMillan North Pole expedition was safe and sound. The radio that kept communication open to Leonard Weeks at Minot, N. D., when all other receivers failed.

There is nothing better than the Crosley 50 for the radio beginner.

There is nothing to excel it in value, unless it be the larger Crosley sets. Stations always come in at the same place. For sale by good dealers everywhere. Other models priced from the two tube 51, at \$18.50, to the Tridyn Special with sloping panel, at \$25. All Crosley Radios are licensed under Armstrong Regenerative U. S. Patent No. 1,113,149. Prices quoted are without accessories.

Prices West of Rockies—Add 10% Write for Complete Catalog

The Crosley Radio Corporation  
Powel Croesley, Jr., President  
5494 Elmwood St. Cincinnati, Ohio  
Crosley owns and operates Broadcasting Station WLW

**Lincoln**  
Collapsible  
**LOOP AERIALS**



**"Europe with Lincoln Loop" writes Radio Expert**

W. W. Roberts—Manufacturer's Agent and Radio Expert—Norfolk, Va., wrote us March 17, 1925:

Gentlemen: You have sent me by parcel post to P. O. Box 222, Norfolk, Va., the following: 1) Loop (2) Lincoln's Patent Tapped Loop Aerials. 2) Ship the above C. O. D. in view of the fact that I do not know to you. It may interest you to know that I have official Radio Broadcast confirmation of European Trans-Atlantic Reception during the recent tests and that I used your Lincoln loop for this reception. Very truly yours, W. W. Roberts.

**Lincoln 4-Point Tapped Loop \$8.00**

The only moderate priced Loop of this type on the market. Fine for all types of "Super-hets"—and neodydine and tuned radio frequency sets, where an outside aerial is impractical. For the requirements of any set where it is desired to vary the inductance of the loop.

**Lincoln Center-Tapped Loop \$6.50**

For any set employing radio frequency amplification. Particularly adapted for "super-hets" requiring a center tap.

**BUY A LINCOLN LOOP**

Sold by good dealers everywhere. If you cannot supply you order direct giving your dealer's name.

**Lincoln Radio Corporation**  
224 North Wells St. CHICAGO

**The "Goode" Two-o-One**



**Guaranteed** BY MAIL ONLY **\$1.89** Postpaid

**QUARTER AMPERE AMPLIFIER-DETECTOR RADIO TUBE**

**GUARANTEED SATISFACTORY**

All "GOODE" Tubes Sold Direct to the Consumer—No Dealer Profits

ONE—"Goode" Detector-Amplifier.....\$1.89  
THREE—"Goode" Detector-Amplifiers..... 5.00  
(All postage prepaid)

The "Goode" Two-o-One A Tube amplifies or detects. It is a quarter ampere, 876 volts, standard base silver tube. Send express or postal money order—New York draft—or personal check to—

**The Goode Tube Corporation**  
Incorporated  
Owensboro (Dept. A) Kentucky

**Finer Selectivity**  
Equip your receiving set with Apex Vernier Dials. They will greatly increase the efficiency of any set. Make tuning positive—bring in distant stations. Your dealer has them. If not, send \$2.00 for Royal Brass Finish—\$2.50 for Satin Silver Finish, or \$3.50 for DeLuxe Gold Plated (24k).

**APEX SUPER 5**  
This highly efficient tuned radio frequency receiver is most advanced in design and construction. An instrument that meets every critical expectation of the radio enthusiast.

Hooped in a highly finished walnut cabinet, complete with Jones Multi-Plug Battery Cable. All settings highly gold plated. Selling at a \$95 complete excepting accessories.

At All Good Dealers  
**APEX ELEC. MFG. CO.**  
1410 W. 59th St. Chicago Dept. 505A

# Two Tube Tandem Rheostat Control

## Panel Space Economy with Double Mounting

In making the change from a one tube set to a two tube set, many Radio fans may have been confronted with the problem of insufficient space for another rheostat, which is necessary in order to have

### WORKSHOP KINKS EARN A DOLLAR—

**T**HERE are many little kinks worked out at home that would aid your fellow Radio worker if only he knew about them. There are new hook-ups, new ways of making parts and various unique ways of operating sets that are discovered every day. Radio Digest is very much interested in obtaining such material. Send them in with full details, including stamped envelope, so rejected copy may be returned. The work must be entirely original, not copied.  
RADIO KINKS DEPARTMENT  
Radio Digest,  
510 North Dearborn St., Chicago

a separate control for the one step of amplification. However, this may be overcome by the plan outlined, which will work very satisfactorily.

First, secure a brass strip 1/16 inch thick, 1/2 inch wide and 7 inches long. Lay this strip flat. Place the two rheostats at each end, as shown, taking care that the rheostats do not extend beyond each end of the strip, then carefully mark the centers where the holes should be drilled. After the holes have been centered punch marked, they should be drilled, using a 1/4-inch drill for the center holes of each rheostat, and a number 18 drill for the two outside holes of each rheostat.

Make a line 2 1/2 inches from each end of the brass strip and bend on these lines into the shape of the letter U as shown at A. Particular care must be exercised in this operation; as the holes will not line up if the brass strip is not bent accurately.

The parts may now be assembled in the following manner: Mount the first rheostat in the usual way, but place the brass form next to the panel and then the rheostat on top; then put in a brass tube, 1/4 inch outside by 1 1/2 inches long, with a 3/16-inch hole and tighten up the screw. Also put on a dial with a hole all the way through. Fasten the second rheostat in place on the top of the brass form, as shown, and pass a rubber or fibre rod, 3/16 inch by 4 inches long, through the brass tube, stopping to put on the 1/4-inch rubber or fiber washer, shown at B, and pass through to the second rheostat. If the second rheostat has a 1/4-inch hole, it will be necessary to use a reducing bushing, which can be made by cutting a slit in a piece of 1/4-inch brass tubing, with a 3/16-inch hole and placing it into the 1/4-inch hole in the rheostat. A rubber or fiber tube, 1/4 inch outside, by 1/2 inch long, with 3/16-inch hole should be passed into the bushing.

It is then only necessary to place a knob on the end of the rubber or fiber rod to complete the job. It might be said that any make of rheostat could be used, provided that rheostat number 1, has at least a 1/4-inch hole.—M. V. Anderson, Edgewood, R. I.

## SINGLE MOUNTING WITH ONE KNOB

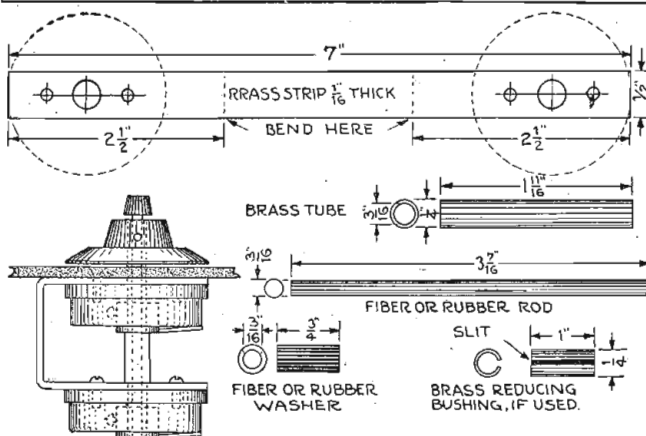

## Fake Electrolyte for Charging Storage Cells

The "wets" of Radioland, who prefer to use storage batteries on the filaments, and perhaps the plates, of their tubes, will be interested in what practically constitutes an expose by the bureau of standards of "fake" charging solutions.

An official bureau statement says, "Changing the solution in a storage battery does not charge it," and continues as follows:

An investigation was recently made at the bureau of standards of certain solutions which were said to charge batteries instantly, or in a short time as compared with the usual process. These tests have shown that batteries containing these solutions, contrary to the claims made for them, behave in accordance with well-established laws of electrochemistry.

Analysis revealed these solutions to contain 38 to 42 per cent of sulphuric acid, which is about the amount in the ordinary electrolyte of an automobile battery when charged. In some of them were found also significant amounts of sodium or magnesium as well as coloring matter. The sodium may have been added as soda, lye, or glauber salts; the magnesium as epsom salts. The use of sodium sulphate (glauber salts) in batteries is an old story. It was suggested more than 35 years ago, but various authorities since that time have stated that such material is without beneficial effect. This has been confirmed by the bureau's recent experiments which show the rate of sulphation of plates to be unaffected by even 4 to 5 per cent of epsom salts or glauber salts.

Comparison was made between batteries containing these solutions and similar batteries containing electrolyte of sulphuric acid of equivalent strength. No essential differences were shown in the charging, the voltage, the efficiency, or the temperature. When a battery is said to be charged it is understood that the battery is fully charged. A battery which

is almost completely discharged may have nearly the same voltage as one that is charged. In this condition it may be able to operate the starter of an automobile, but this fact can not be taken as evidence that the battery is fully charged. It takes as long to fully charge a battery containing one of these solutions as to charge a similar battery containing the ordinary electrolyte.

The indiscriminate addition of these solutions to a battery is not advisable, although in some cases no great harm may be done. If the solution is used to replace the electrolyte of a completely discharged battery as is usually the case, the battery may be spurred on to give a little more current because the plates retain a surplus of active material. When the battery is recharged by an electric current the specific gravity will rise much too high. This is because the acid formed at



**325 RADIO Storage "B" Battery**  
Lasts Indefinitely—Pays for Itself  
Economy and performance unknown to you. Remembered at a negligible cost. Approved and listed as Standard by the Radio Authorities, including the Radio Laboratories, Fed. Lab. Standards, Radio News Lab., Lehigh, Inc., and other important institutions. Recharge with 50% Sulfuric Battery, or use as emergency acid and lead. Extra heavy glass jars. Heavy, rugged plates. Order yours today!  
**SEND NO MONEY** Just state number of batteries wanted and we will ship on order received. Extra Offer: 4 batteries in series (30 volts) \$12.35. For expression of our amazing batteries. 5 per cent discount for cash with order. Mail your order now!

**WORLD BATTERY COMPANY**  
1219 So. Wabash Ave., Dept. 76, Chicago, Ill.  
Makers of the Famous World Radio "A" Storage Battery.  
Prices: 6-volt, 100 Amp. \$15.00; 100 Amp. \$16.00; 110 Amp. \$16.00; 110 Amp. \$16.00.  
All equipped with Solid Rubber Cases.  
**World FOR STORAGE BATTERIES**

the plates by the charging current is added to the acid already present in the solution. In the bureau's experiment it rose to 1.365. This is not desirable because the local action or self discharge within the battery is materially increased. A battery containing one of these solutions lost 47 per cent of its charge in four weeks as compared with 8 per cent which was lost by a similar battery with the ordinary solution. Batteries containing solutions of higher than normal specific gravity often give less capacity at high rates of discharge, as when cranking the engine of an automobile, depending upon the behavior of the negative plates. The higher the specific gravity of the electrolyte the more injurious is the action upon the separators. It is a well-recognized principle in battery operation that acid should be added only to replace that which may have been spilled, or in rare instances to adjust the specific gravity to the required standard after the completion of a full charge.

Although the materials and coloring matter considered individually may be harmless, the disadvantages in using such solutions more than offset any temporary gain.

## Wavy Effect on Panels

A beautiful wavy effect can be applied to a panel by covering the tip of your thumb with a bit of felt and using a gritty scouring powder as a cutting agent and cover the entire panel surface with row after row of thumb whorls. A feather duster can be used to remove the surplus powder. This leaves a dizzy, mesquite effect. On soft panels, straight rubbing with a dry scouring powder gives a pleasant, dull grain effect.—J. P. Kennedy, South Bend, Ind.

## OLD MAN STATIC "KILLED" AT LAST

Statchoke Has Starred the Radio World—Insures Clear, Long Distance, Summer Reception.

Kansas City, Mo., May 15. (Special)—The long promised invention which insures clear, long distance, "summer radio" without the agony of static, has just been announced here. Radio experts and fans who have tested this new imported invention, pronounce it marvelous. Awarded Certificate of Merit by Radio News of Canada.

In addition to reducing static to a minimum, the Statchoke increases the volume as well as clarity of distant reception, sharpens the selectivity of tuning in, eliminates that harshness of the tubes so noticeable on local loud speaker reception and acts as a safety lightning arrester.

The Statchoke somewhat resembles a small transformer, and by a system of coils it allows only the correct current value to enter the set, choking out other high current variation from the aerial, which is passed off through a secondary ground connection.

So confident are the American distributors that Statchokes will enter the long distance summer reception that they have set aside 25,000 units for initial distribution direct to the radio fans, at a special price of only \$2.50 each. If interested write today to Radio Dept., Imperial Laboratories, 2585 Coca Cola Bldg., Kansas City, Mo., and the Statchoke will be sent you by insured mail. Write today as this is a special offer and may not appear again.

*It isn't a genuine WD-11 unless it's a Radiotron*

**WD-11 Radiotron**

**Buy Tubes by Name**

**WD-11 Radiotron**

## USE YOUR RADIO SET ALL SUMMER

Eliminate Your Power Noises and Reduce Static and Re-Radiating Squeals at least 50 Per Cent WITH THE KANE ANTENNAE

We will sell you the working drawing with instructions for erecting this wonderful Antennae for a dollar bill. If after looking over this drawing you decide you would rather have a factory-built Antennae than build one yourself, we will take back the drawing and allow you full purchase price on an order for an Antennae.

|  |         |
|--|---------|
| The Special Kane Antennae for Radiola Super-Het's.....                   | \$ 6.50 |
| The Regular Kane Antennae for all sets that use a ground connection..... | 13.00   |

Working Drawing with Instructions for Erecting, \$1.00 (Stamps Not Accepted)

Postpaid to any part of the United States or sent C.O.D. when 25% of price accompanies order.

**THE KANE ANTENNAE COMPANY, Aberdeen, Washington**

# Questions and Answers

### Strange Knocking Noises

(18642) RNM, Crab Orchard, Tenn.  
Several times within the last two years I have been bothered with knocking noises in the phonograph. They start with a slow knock and increase to a speed so that they can be counted. The last time it happened I walked up to the lighting switch and on touching it I received a shock. Putting the antenna blade close to the ground terminal I could see sparks jumping the gap. What caused this?  
A.—It is very probable that the noise and sparking which you describe was static. Whenever an antenna is big or whenever it is located on a high building, etc., it will attract static to such an extent as to make it spark. Static sparks have been known to jump a gap of 10 inches at times.

### Interference from an Ice Cream Freezer

(15673) WAI, Lamasas, Texas.  
How can I stop the interference produced by an ice cream freezer? Whenever it is in operation it impairs the reception of all receiving sets in the neighborhood.  
A.—We are not familiar with ice cream freezers so we cannot advise definitely how to remedy the trouble. However, if there is a motor in the machine we would advise that you look over it first. A sparking commutator is usually the cause of the trouble. If you cannot locate the trouble you can overcome it largely by placing a cage made of fly screen around it and grounding it.

### Lack of Volume on High Waves

(13670) CWR, Holyoke, Mass.  
I have a regenerative set which works wonderfully on the low waves. On the higher waves, however, it does not work as well. What is the matter?  
A.—The trouble in your case is one of two things. Either you do not have enough turns on the tickler so that you do not get enough regeneration on the higher waves, or else the fundamental of your antenna falls at upper band of broadcasting. A regenerative set does not oscillate as well if at all on the fundamental of the antenna. To overcome the first add more turns to the tickler. If you find that this does not improve results, put a loading coil in series with the antenna to raise the fundamental above the broadcast band. The loading coil should consist of about 40 turns of bell wire on a 4-inch tube.

### Mechanical Rectifier for Batteries

(13586) ELE, Verdun, P. Q.  
I wish to make a storage battery charger. I heard a lot about the mechanical type of rectifier. Please give me a hook-up and instructions for building a mechanical storage battery charger.  
A.—We would not advise the use of a mechanical type of a storage battery charger made at home. Even the factory made ones do not work too well. Made at home it would only spark and waste current away. The sparking would interfere with the near-by Radio sets. If you wish to build a charger we would suggest the charger described by Mr. Fournier in December 20 issue of Radio Digest.

### Copper Tubing for Antenna

(13582) EJM, Waterbury, Conn.  
I have heard that reception can be improved by the use of copper tubing for an antenna. Is this correct?  
A.—It is not correct. The only thing the use of copper tubes does is increase the antenna's capacity to the earth. It is used by transmitters largely because it is rigid.

### ELLICOTE SUPER RADIO RECHARGER

No Tubes, A or B Batteries. Operates Speaker, Clarity, Distance. Write Ellicote Radio Co., Box 193, Buffalo, New York.

## PATENTS

Time counts in applying for patents. Don't risk delay in protecting your ideas. Send sketch or model for instructions or write for FREE book, "How to Obtain a Patent" and "Record of Invention" form. No charge for information on how to proceed. Communications treated confidential. Prompt, careful, efficient service. Clarence A. O'Brien, Registered Patent Attorney, 2009-A Security Bank Bldg. (directly across street from Patent office), Washington, D. C.

### SEND IN YOUR Paralyzed Tubes

to be Restored to Health in Our Laboratory  
**98%** of your worn-out tubes can be put in first class condition.  
We can REACTIVATE UV-201A, C-301A, UV-199, C-299 and any other thoriated filament such as Atlas, Magnetron, Forest, etc.  
We cannot reactivate UV-200, C-300, WD-11 or WD-12 tubes, nor can we reactivate burned out tubes.  
**It Costs You Only \$1.00**  
If we can restore your tube so that it operates satisfactorily. If we are not successful, our charge is only 25¢.  
Why pay the price for new tubes when we can make yours as good as new for only \$1.00?  
MAIL IN YOUR TUBES TO US FOR PROMPT RETURN, Patent Post, C. O. O.  
**A. O'CONNOR & COMPANY**  
9702 Euclid Ave. Cleveland, Ohio

### Non-Regenerative Circuit

(13437) LJM, Cedar Rapids, Iowa.  
I am thinking of building a one tube receiving set and would like to know of a good hook-up that will not radiate and be selective. The set I want must be selective as it is possible to make a one tube outfit and it must have a clear tone without distortion, and if possible it should not radiate to annoy my neighbors. Long distance reception is no object. If it will bring in the stations good as far away as Chicago I will be satisfied. I desire to use the C-299 or UV-199 tubes. Do you have any instructions for a set that will fill the above requirements?  
A.—We are showing two hook-ups from which you may have your choice. The first one is the non-regenerative circuit. This circuit will not radiate, will not howl and will not disturb others. The

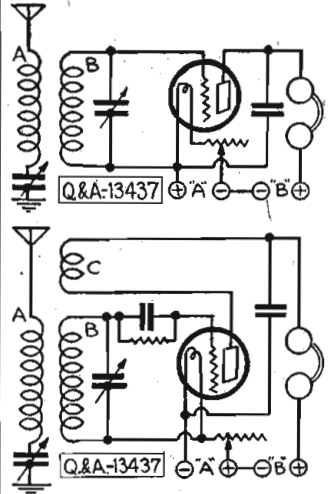

quality of music received by it will be surpassed by the crystal only. However, it will not bring in very much DX. You may, and you may not get Chicago stations. If you get them they will not be very loud. The second is a single tube regenerative set. This set will, if operated properly, bring in the music as clear as the non-regenerative, however, if not it will distort the signal. If operated carelessly it will radiate and howl. It will also bring in DX and you will have no trouble bringing in Chicago stations and those on the east coast should come in good. The first part of both these sets are alike. That is, coils A and B. Coil A should consist of about 30 turns of number 18 wire wound in the basket fashion. The secondary, that is coil B, should consist of about 40 to 45 turns of number 18 wire wound in the basket fashion. The

### ZELLERS RADIO LOG BOOK, 25 Cents

Zellers Company, Hooper, Nebraska.

Buy right and make money. Standard lines, parts, sets, shipped now. Fast service—hard-to-get items—extra good discounts. Get our catalogue No. 8. It shows you!

**W. B. FUSTEBER**  
RADIO SUPPLY CO.  
2121 Locust St. St. Louis, Mo.

### EXCLUSIVE TERRITORY

is now being allotted as a new line of **BROADCAST RECEIVERS**  
Popular Priced—Liberal Discounts and Exclusive Territorial Arrangement  
**DEALERS**  
ARRANGE NOW FOR TERRITORY and be prepared when the rush comes  
**GENERAL DISTRIBUTING CO.**  
P. O. Box 69  
ROOK ISLAND, ILL.

Regardless of the Crystal You Are Using—  
**You Ain't Heard Nothin' Yet**  
"Rocky Mountain Steel Galena"  
Mounted Without Heat  
**AT YOUR DEALER OR DIRECT**  
30c Postpaid  
**The Reynolds Radio Co., Inc.**  
Denver, Colorado

size of both these coils is about 4 1/2 inches in diameter. These coils should be arranged so that the distance between them can be varied. They should be parallel to each other. The tickler, that is coil C, consists of about 25 turns of number 18 wire wound on a basket form about 2 inches in diameter. It should be placed on a shaft so that it can be rotated. While any condenser will do in series with the aerial the one across the secondary should be a low loss condenser. The rotary plate is indicated in the drawing and it is important that it should be connected as indicated.

Through error, the grid leak and grid condenser have been omitted from the non-regenerative circuit. In both circuits the grid condenser should be .0025 mfd. while the leak will be in the neighborhood of 5 megohms. Variable condenser is .0005 mfd., while the bypass is .002.

### Sending Out Time Signals

(13467) WSE, Harrisburg, Pa.  
Will you please tell me how the broadcasting stations send out the time signals?  
A.—The time signals sent out by the broadcasting stations are usually telegraphed to the station from some watch factory or from some observatory or other place that keeps standard time. A ticker is usually arranged so that it operates a buzzer at the station, the buzz of which is sent out.

### Amateur Transmitting License

(13620) FWH, Auburn, Ia.  
Asks what he has to know to get an amateur operators' license. Also, if he can use a Western Electric C.W. 938 transmitter. This transmitter is arranged to transmit on waves of 255, 297, 345, 400 and 600 meters.

A.—To get an amateur operators' license you must first be able to send and receive in the international code at a speed of at least ten words per minute. You must have a knowledge of theory to be able to explain the operation of your sending and receiving set. You must be able to tell how you would tune your transmitter to the correct wave length by the use of a wave meter. You must be able to explain how to adjust your prospective sending and receiving set. You must have read and studied the Radio laws and regulations governing stations in U. S. and of the world. You must have memorized the law of secrecy. You cannot use the transmitter which you mention without re-hulling it so that it will send on a wave length below 200 meters.

**PATENT ATTORNEYS**  
PATENTS. Booklet free. Highest references. Best results. **WATSON E. COLEMAN**, Patent Lawyers  
644 G Street, Washington, D. C.

**Burns**  
**PERFECT REPRODUCER**  
Tone loud and pleasing. Hand-some material and design.  
**Black—\$22.50 Shell—\$25.00**  
**AMERICAN ELECTRIC CO.**  
State and 64th Sts. Chicago

**NO STATIC**  
**NO DANGER OF LIGHTNING**  
**THE Antennaphone**  
IMPROVES RECEPTION  
Gives wonderful results with any radio set. Not attached to but merely placed under the telephone. Price One Dollar. Complete with insulated wire and simple instructions. At Your Dealer or Mailed C.O.D. on 3 days approval.  
**Antennaphone Co., 90 West St., N. Y. C.**

### Radio Tubes Exchanged

Send us your old tube—any make—any condition—and we will send you a Brand New Guaranteed Tube, of whatever type you require, for \$1.75. All shipments insured. Parcel Post. C. O. D. Send no money—order today.  
**\$1.75 C.O.D.**  
**D-R-C RADIO CO.**  
327 S. LaSalle St. Chicago, Ill.

**Radio Dealers HEADQUARTERS**  
**NEW CATALOG READY**  
Bigger, better than ever. Write on your letterhead for discounts and catalog **AD1003**  
**WAKEM & McLAUGHLIN**  
225 E. ILLINOIS ST. — CHICAGO.

### Large Outside Loop

(13561) JEW, Oakland, Okla.  
I intend to build an outside loop antenna. I intend to put it on a square 30 feet on the side. This antenna is to be 30 feet above the ground with a 30-foot lead to the set. Would this antenna be better than a flat top with a 30-foot elevation?  
A.—An antenna of this kind would not be better than a flat top. It would be inferior when compared with it. The 30-foot lead would cancel all directional properties of the loop.

### Charging Storage Batteries from 250 V.D.C.

(13673) EEM, LaFerty, Ohio.  
What is the best way to charge a storage A and B battery from 250 volts D.C.  
A.—You can charge these batteries by connecting a resistance in series with the battery. You should have an ammeter to indicate the charging rate. The charging rate, which may be varied by the size of the resistance should be about 4 to 6 amperes for the A battery and about 1/2 to 1 ampere for the B battery.

### Station Call Letters

(13666) ALS, Royal Oak, Mich.  
What are the call letters of a low wave station in University City. They begin with KF and they broadcast at 1 a. m., Eastern standard time.  
A.—The station you heard is KFVE. It was started May 6.

### List of Amateur Stations

(13542) BE, Fairview, Kans.  
Could you please give me the call letters and wave length of amateur broadcasting stations?  
A.—We wish to advise that amateur stations are not broadcasting stations. They are transmitting stations which transmit to one certain station only. We could not give the list of them as they number somewhere around 17,000. A call book contains the list you want. The amateurs use various bands, all of which are located below 200 meters. They are as follows: 150-200, 75-85.7, 37.5-42.8, 18.7-21.4, 4.69-5.35, and also a small band for use in beam transmission in the neighborhood of 1/4 meter. The amateur phone stations are all in the band between 170 and 180 meters. CW only is allowed on the other wave lengths.

### Men to build radio sets in spare time.

Leon Lambert, 501-H Kaufman Bldg., Wichita, Kansas.

## \$10 IS ENOUGH

You can hear programs from cities 400 to 1,000 miles away on Lambert Crystal Sets and you won't need tubes or batteries.  
Picture of set and particulars free.  
**LEON LAMBERT**, Wichita, Kansas  
Dealers write for discounts.

## Get Rid of Static

Lambert's Static Stopper does the work. Particulars free  
**LEON LAMBERT**  
501-A Kaufman Bldg., Wichita, Kansas

## GO into the RADIO BUSINESS

We specialize in Equipping New Dealers with entire stock — **ADVICE FREE.**  
Send for Our Radio **CATALOG & BARGAIN LISTS**  
Wholesale Only  
**MANHATTAN RADIO CO.**  
112 Trinity Place New York City

## OUT AT LAST!

**\$2.95**  
"The Hawley"—A complete everlasting acid nickel-iron type storage "B" battery. Special offer—4-22 1/2 volts (50 volts), \$10.00; 11 1/2 volts, \$12.50; 135 volts, \$14.75; 15 1/2 volts, \$16.80. Equipped so that a special detector or amplifying voltage is easily had. Chemical included separate. Nothing to put together or buy extra. Elements are not stamped on steel affair and do not rust—the connector is 99% pure nickel. Test—they're firmly fastened and DON'T DROP OFF. New heavy shock-proof glass cells—and they're closed on the top. The only battery having same of this type. For those wishing to build their own—get the famous "Hawley" knock-down kits—more parts, all ready nickel connected elements, the special cells with special closed-in top and the worth-while patented pending feature. New summer time prices—priced lower than any other set on the market with all the above extra features. All voltages. The only type of battery sold on a 3-year guarantee with any 1/8, and, or, but, Sample call 35c prepaid; 35-cent radio catalog free. Order or write for my literature, guarantee and testimonials. Same day shipments. Will ship C. O. D. if desired—simply pay attention. Wholesale Address: B. D. Smith, 31 Washington Ave., Danbury, Conn.





**Usual Dial**  
Note crowding of short-wave stations (A) onto lower dial numbers.

**Grebe Dial**  
All stations have equal spacing around the dial.



**Grebe S-L-F**  
(straight line frequency)  
Condenser

**QUICK**, easy, certain tuning-in of all stations with the Synchronphase is assured by the S-L-F Condensers. These diagrams show why.

## Speedy, Accurate Tuning due to this new type of condenser

**T**HE Grebe S-L-F (straight line frequency) Condenser provides equal spacing for all stations, as the above diagram indicates. The short-wave stations are not crowded onto the lower dial numbers, a condition which usually adds to the difficulty in accurately tuning these stations. This difficulty has been overcome in the Grebe S-L-F Condenser by having the plates follow a special type of the hyperbolic spiral series of curves.

This exclusive Grebe feature is but one of several which have already won for the Grebe Synchronphase an enviable reputation for unusual performance.

*Ask your dealer to demonstrate the practical workings of these Grebe features*

**A. H. GREBE & CO., Inc.,** Van Wyck Blvd., Richmond Hill, N. Y.  
Western Branch: 443 So. San Pedro Street, Los Angeles, Cal.

This Company owns and operates station WAHG



The excellence of Synchronphase results is the reward for years of painstaking care.

*Doctor Wm.*

**THE GREBE SYNCHROPHASE**  
TRADE MARK



Trade Mark  
Reg. U. S. Pat. Off.

All Grebe apparatus is covered by patents granted and pending.

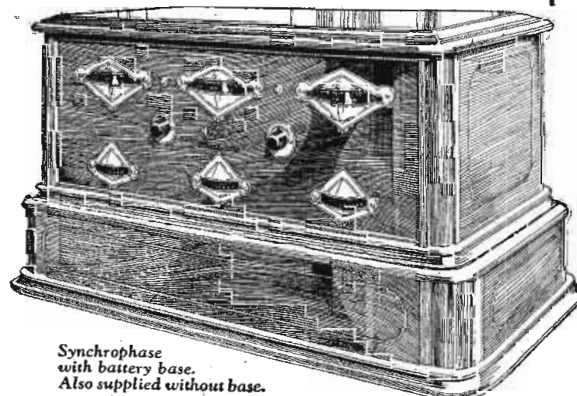

Synchronphase with battery base. Also supplied without base.